

User Guide

FreeSpeak II[®] Base Station system



Part Number: 399G169 Rev B

Date: April 27, 2016

Document Reference

Clear-Com FreeSpeak II User Guide

Part Number: 399G169 Rev B

Legal Disclaimers

Copyright © 2016 HME Clear-Com Ltd.

All rights reserved.

Clear-Com and the Clear-Com logo are registered trademarks of HME Electronics, Inc.

The software described in this document is furnished under a license agreement and may be used only in accordance with the terms of the agreement.

The product described in this document is distributed under licenses restricting its use, copying, distribution, and decompilation/reverse engineering. No part of this document may be reproduced in any form by any means without prior written authorization of Clear-Com, an HME Company.

Clear-Com Offices are located in California, USA; Cambridge, UK; Dubai, UAE; Montreal, Canada; and Beijing, China. Specific addresses and contact information can be found on Clear-Com's corporate website:

www.clearcom.com

Clear-Com Contacts

Americas and Asia-Pacific Headquarters

California, United States

Tel: +1.510.337.6600

Email: CustomerServicesUS@clearcom.com

Europe, Middle East, and Africa Headquarters

Cambridge, United Kingdom

Tel: +44 1223 815000

Email: SalesSupportEMEA@clearcom.com

China Office

Beijing Representative Office

Beijing, P.R.China

Tel: +8610 65811360 / 65815577

Table of Contents

Document Reference	2	
1	What is FreeSpeak II Base?	6
1.1	2-wire, 4-wire and wireless intercom	6
1.2	Flexible configuration	7
1.3	Live set-up and control	7
1.4	System capacity	8
2	Using the Base Station	9
2.1	About the Base Station	9
2.2	Base Station front panel	9
2.3	What is a Keypad?	10
2.4	FreeSpeak II Base rear connectors	12
2.5	Base Station rear connector pinouts	13
2.6	FreeSpeak II Base Station menu 'at-a-glance' guide	15
2.7	Networking/IP issues	17
2.8	Base Station menu overview	19
3	Installing the antennas	21
3.1	Introduction	21
3.2	Site survey	24
3.3	Standalone site survey	25
3.4	Using an antenna with a Fiber connection	27
3.5	Interpreting the Site Survey screen	28
3.6	How to put a belt-pack into Site Survey mode	29
3.7	Cable compensation	30
4	Using the antennas	33
4.1	Introduction	33
4.2	Antenna connectors	34
4.3	FreeSpeak II Base 1.9 GHz/2.4 GHz	35

4.4	Radio frequency (RF) issues	35
5	Using the FreeSpeak II Splitter (FSII-SPL)	37
5.1	Introduction	37
5.2	Splitter front panel	39
5.3	Splitter rear connectors	40
5.4	Splitter software version	40
6	Using Beltpacks	42
6.1	Registering Beltpacks	42
6.2	Unregistering Beltpacks	46
6.3	Assign channels to Beltpack keys	47
6.4	Beltpack default settings	52
7	Beltpack features	55
7.1	Menu key operation	55
7.2	Master volume low level limiter (beltpacks)	57
7.3	Configurable eavesdropping	58
7.4	AA Battery Type: Alkaline/NiMh	59
7.5	Using the beltpack functions	60
8	Roles	63
8.1	About FreeSpeak II Base Roles	63
8.2	Default Role settings	63
8.3	Changing Channels on beltpacks	64
8.4	Change beltpack settings	67
8.5	How to create Roles for beltpacks	67
8.6	Save Settings	69
8.7	Fixed Roles	71
9	Core Configuration Manager (CCM)	74
9.1	How to access the CCM	74
9.2	CCM walkthrough	75
10	Configuring audio routes	81
10.1	About audio routes	81

10.2	Example audio assignment.....	86
10.3	Change key assignments on the Base Station.....	91
10.4	Configure a one-to-one connection.....	93
11	Connecting different systems.....	94
11.1	Interconnection	94
11.2	Connecting FreeSpeak II Base to other intercom devices	94
11.3	Connecting 2-wire equipment	94
11.4	Connecting to 4-wire equipment	95
11.5	Port function (to matrix or to panel)	95
12	Upgrading devices	98
12.1	About upgrading devices.....	98
12.2	How to upgrade your devices.....	98
13	Powering your system	100
13.1	Powering the FreeSpeak II™ Base.....	100
13.2	Powering wireless belt packs	100
13.3	Power 2-wire belt packs from the Partyline.....	100
13.4	Powering the transceiver antennas.....	100
13.5	Powering the Antenna Splitter	101
13.6	Recommended powering and cable lengths for a FreeSpeak II Base System	101
14	Federal Communications Commission (FCC) compliance.....	103
15	Specifications.....	105

1 What is FreeSpeak II Base?

The FreeSpeak II Base consists of wired and wireless beltpacks. Wireless beltpacks roam freely using a cellular network of antennas (1.9 and 2.4 GHz)

Typical FreeSpeak Configurations

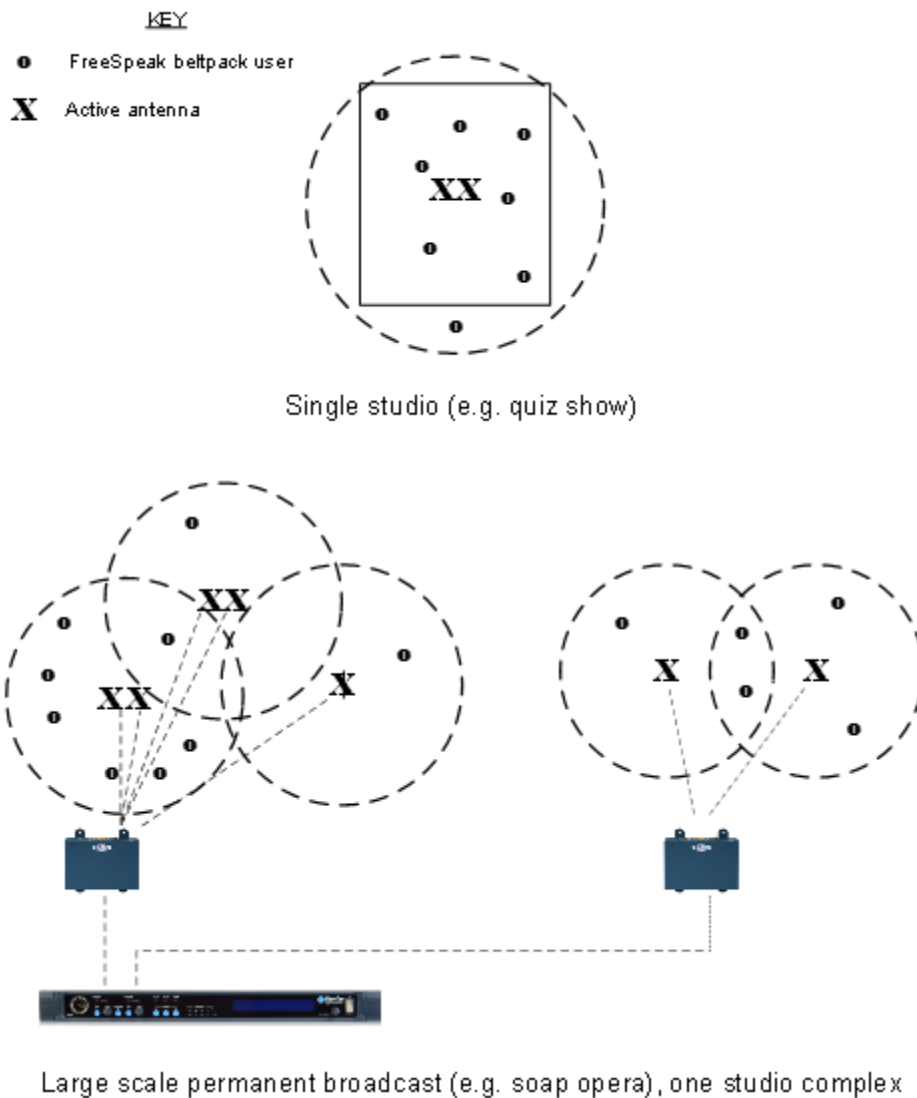

1.1 2-wire, 4-wire and wireless intercom

These different devices communicate seamlessly.

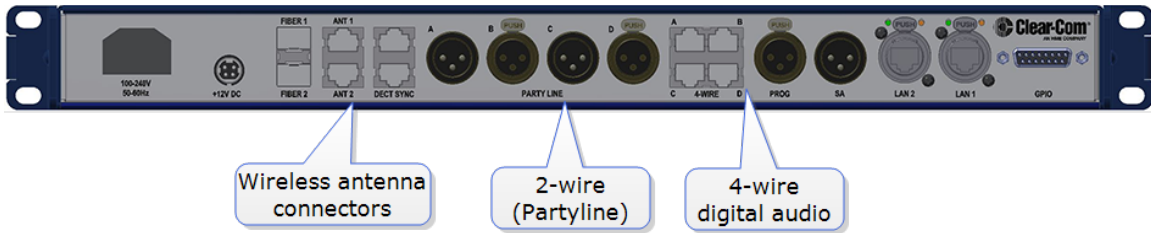

1.2 Flexible configuration

Pre-configured beltpack Roles allow both rapid set-up and flexible configuration.

- Use simple default set-up; all beltpacks on Channel 1 and 2
- Customize the set-up to suit your needs.
- System has either 25 (FSII-BASE-II) or 5 (FSII-BASE-II-5) beltpack Roles. FSII-BASE-II-5 offers a license to upgrade to 25 beltpacks if required.

1.3 Live set-up and control

Use the front panels of the Base Station, or the browser-based Core Configuration Manager (CCM).

Press **Menu** button on the Base Station to access controls:

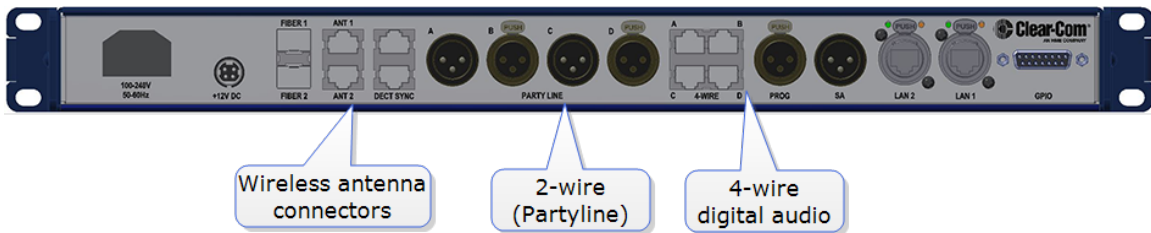

Browser-based **Core Configuration Manager** (CCM), accessed via device IP address.

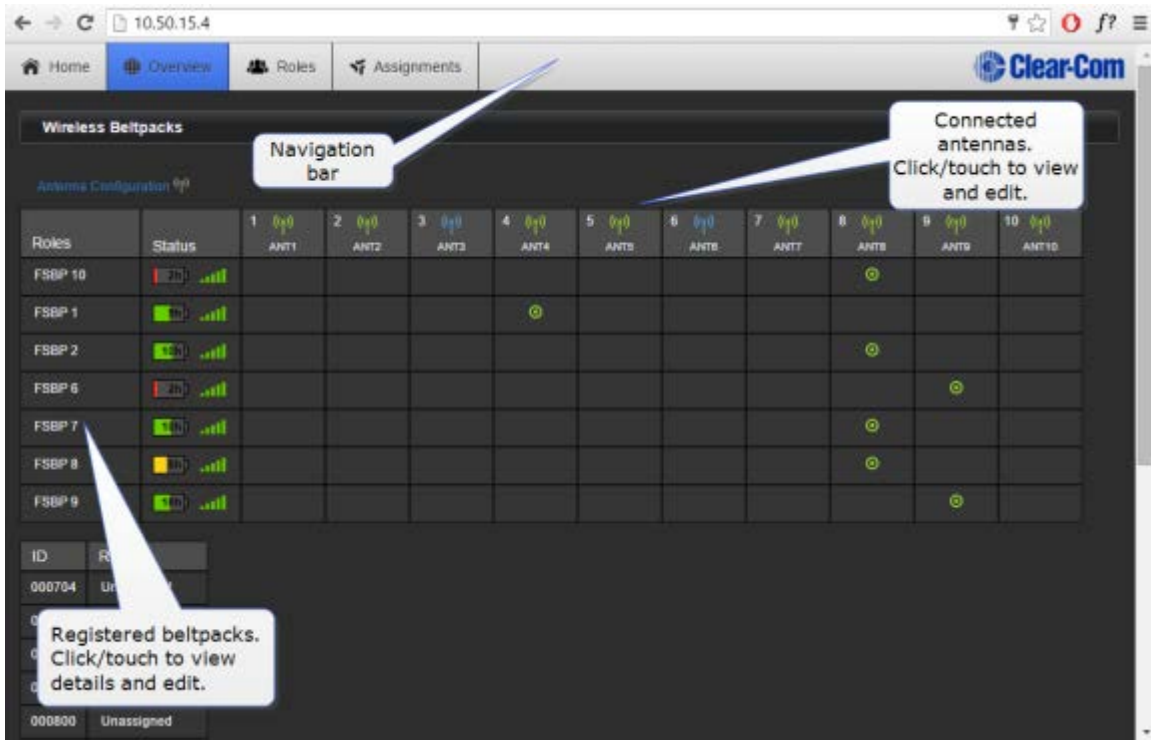

1.4 System capacity

- Up to 25 wireless beltpacks, 10 antenna/transceivers per base
- FSII-BASE-II: 25 beltpack capacity.
- FSII-BASE-II-5: 5 beltpack capacity. To upgrade to 25 beltpacks you need to obtain a licence from your Clear-Com dealer.
- 12 Partyline Channels
- 12 Group set-ups

2 Using the Base Station

2.1 About the Base Station



The FreeSpeak II Base Station routes communication to and from wireless beltacks. It provides a control point for audio and allows the user to configure the system, either from the front panel menus or using the online configuration manager.

- Press **Menu** button to configure from the Base.

2.2 Base Station front panel



A	USB port. Use when registering beltacks to the Base Station. Also use when upgrading device or saving/restoring system settings.
B	Base headset connector (4-pin XLR female).
C	Menu button. Push to enter menu mode and control system settings. Push again to exit menu mode, or leave to time-out.
D	Mode button. Use to view antenna performance in base menu screens. Toggle between diagnostic view and normal keyset view.
E	Push to toggle headset microphone on and off.

Keyset	A Keyset is a set of controls associated with an audio assignment. On the Base, a Keyset is made up of a viewing screen and three controls (a rotary and two push buttons). The viewing screen shows a Channel and any associated messages. The rotary controls volume to that Channel, and the push buttons control Call and Talk to the Channel. The viewing screens are also used to display menu and mode information.
F	Stage Announce. Allows the Base operator to talk on the Stage Announce output. Push and hold to talk. Pressing the SA button on the Base triggers a relay which can be sent to an external device
G	All Talk. Allows the Base operator to talk to all wired and wireless beltacks (2-Wire and 4-Wire). Push and hold to talk.
H	Remote Mic Kill (RMK). Allows Base operator to remotely unlatch all beltack talk keys, wireless and wired.
I	Status LED 1 = Antenna warning light. If green, all antennas are online. Status LED 2 = Beltack warning light. If green all BPs have sufficient battery power. If either light is amber (or red), you can press the mode button to check the issue in the diagnostics screens.
J	Controls overall volume to the Base headset. This includes Channels, program feed and any other available audio. Turn rotary to adjust volume, push to turn headset sound on and off.
K	Program feed to Base headset volume and control. Turn rotary to adjust volume, push to turn feed on and off. (Does not affect program feed in Channels).

2.3 What is a Keyset?

A Keyset is a set of controls associated with an audio assignment. The Base Station has 4 audio assignments (Keysets), and a beltack has two main audio assignments (Keysets).

2.3.1 Main Station Keysets

The Keyset on the Base Station is made up of four viewing screens, each with an associated rotary controller, a Call key and a Talk key. These controls display and regulate the audio routes associated with the Base. As well as

controlling audio assignments, the viewing screens display menu options and wireless diagnostics.

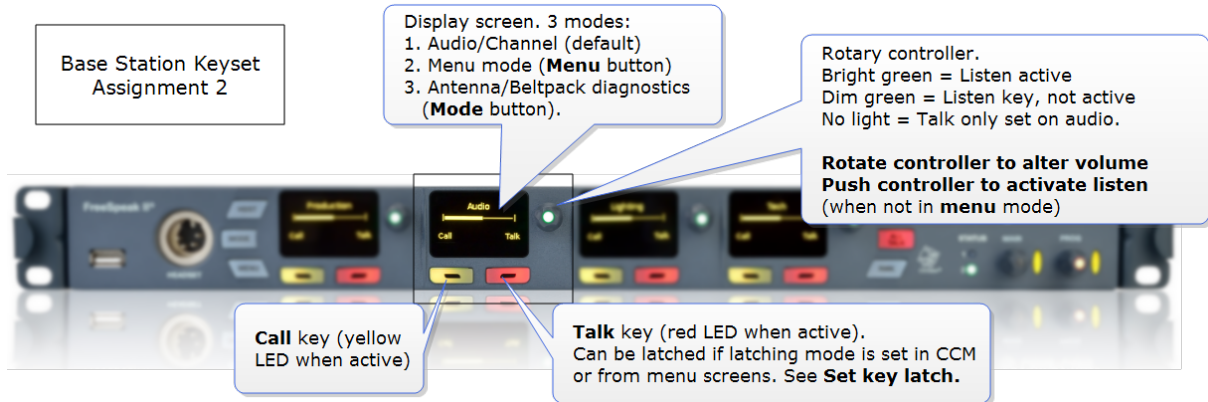

2.3.2 Beltpack Keysets

The Keypad on a beltpack has one screen and two sets of controls, to the left and right of the screen. The main assignments are on keys A and B, and subsidiary assignments are on C and D. Additionally, the Reply key can be over-riden with an audio assignment. The default set-up for a beltpack puts Channel 1 on keys A and C, and Channel 2 on keys B and D.

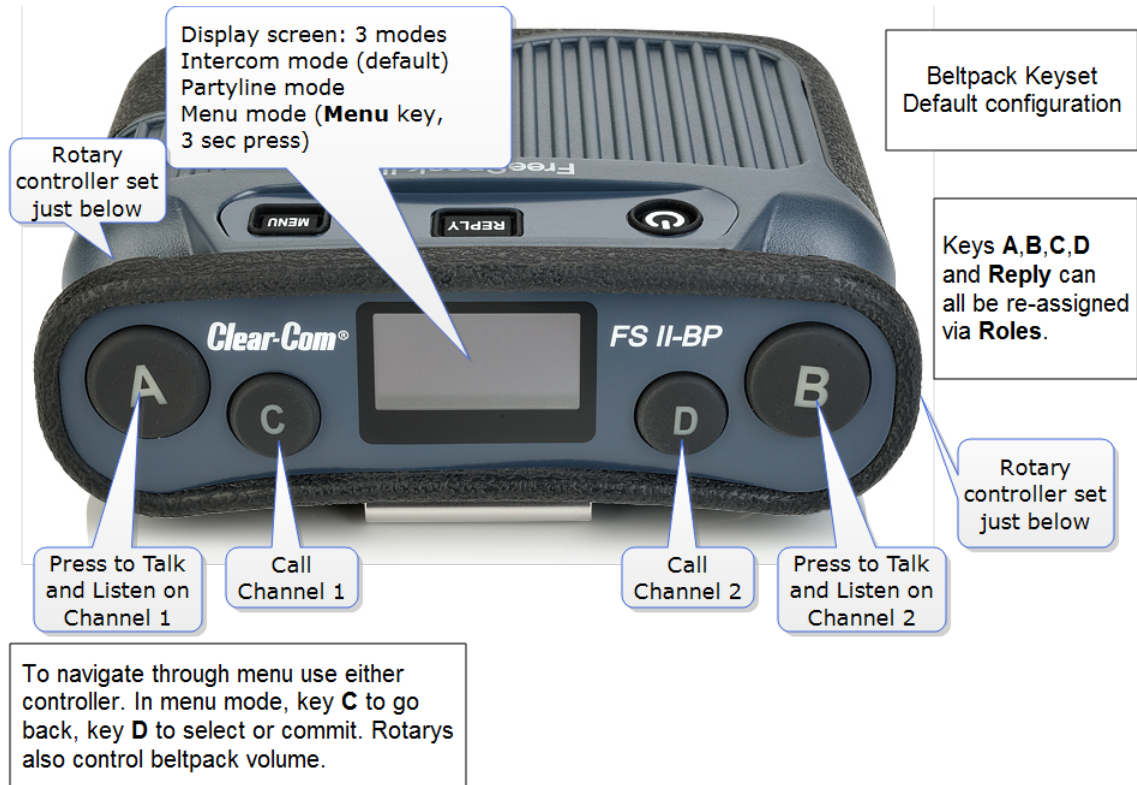

2.4 FreeSpeak II Base rear connectors

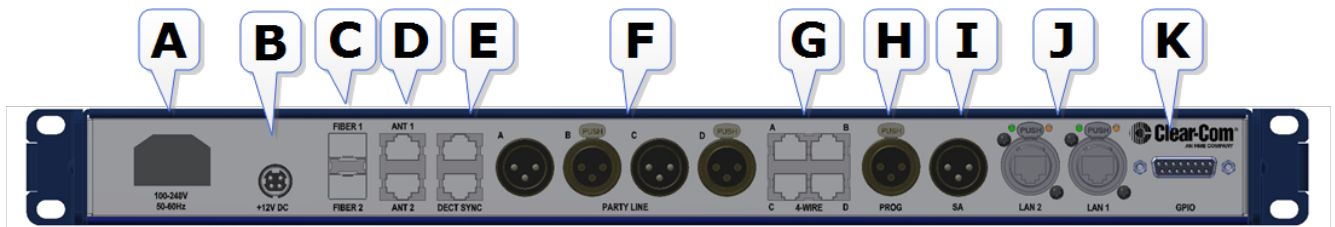

Control	Description
A	Power connector. Mains power lead with internal current converter.
B	Power connector. DC wallwart power lead (Part # 453G032, 12V DC, 60W). Use connector A or connector B or both to guard against power failure.
C	Fiber connector to FS II splitter (Part # FSII-SPL). Used with Fiber module (Part # HCI-SMFO or MMFO)
D	RJ45 connector to antenna (FSII-TCVR-19, FSII-TCVR-24) or splitter.
E	DECT Sync. RJ45 connector to another Base Station. Can also be used to synchronize to other Clear-Com DECT devices. In some cases, you will need a cross-over cable instead of a standard cable.
F	XLR Partyline connectors (standard microphone cable). Note: If power is enabled on these ports the power operates across a pair of ports, A and B, C and D. Be sure to null the ports whenever cabling arrangements are changed.
G	RJ45 connectors for 4-wire intercom. These ports can change pin polarity according to whether they are connecting to a matrix or another device.
H	XLR connector (standard microphone cable) for Program Feed input, typically from a mixing console or audio player. Adjust levels in Audio Settings/Program Input in the Base Station menus.
I	XLR connector (standard microphone cable) for Stage Announce output.

Control	Description
J	2 x RJ45 ports. These can be used for network connection or for daisy-chaining devices. Note: The ports share an IP address, so only one network connection is possible (either port can be used).
K	GPIO connector.

Note: For connection between the Base and antenna/splitter and digital audio feeds, Clear-Com recommends shielded Cat 5/6 cable. Use of other cable can result in shorter cable runs and other performance problems.

2.5 Base Station rear connector pinouts

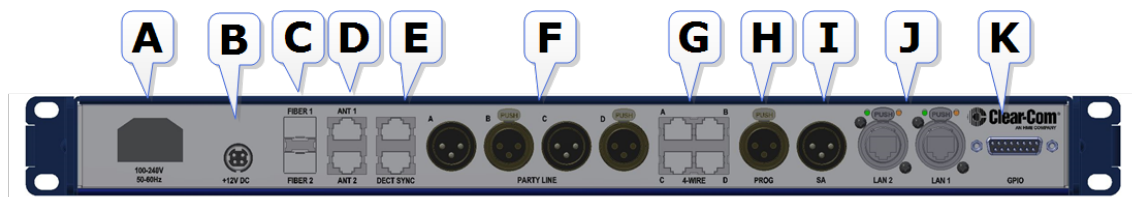

2.5.1 DECT SYNC (connector E)

Pin	Sync In	Sync Out
Pin 1	DECTSYNC +	DECTSYNC +
Pin 2	DECTSYNC -	DECTSYNC -
Pin 3	8 KHZ+	8 KHZ+
Pin 6	8 KHZ-	8 KHZ-

2.5.2 Partyline (connectors F)

Pin	Description
Pin 1	Ground (shield)
Pin 2	Power
Pin 3	Audio

2.5.3 4-wire intercom (connectors G)

GPIO (connector K)

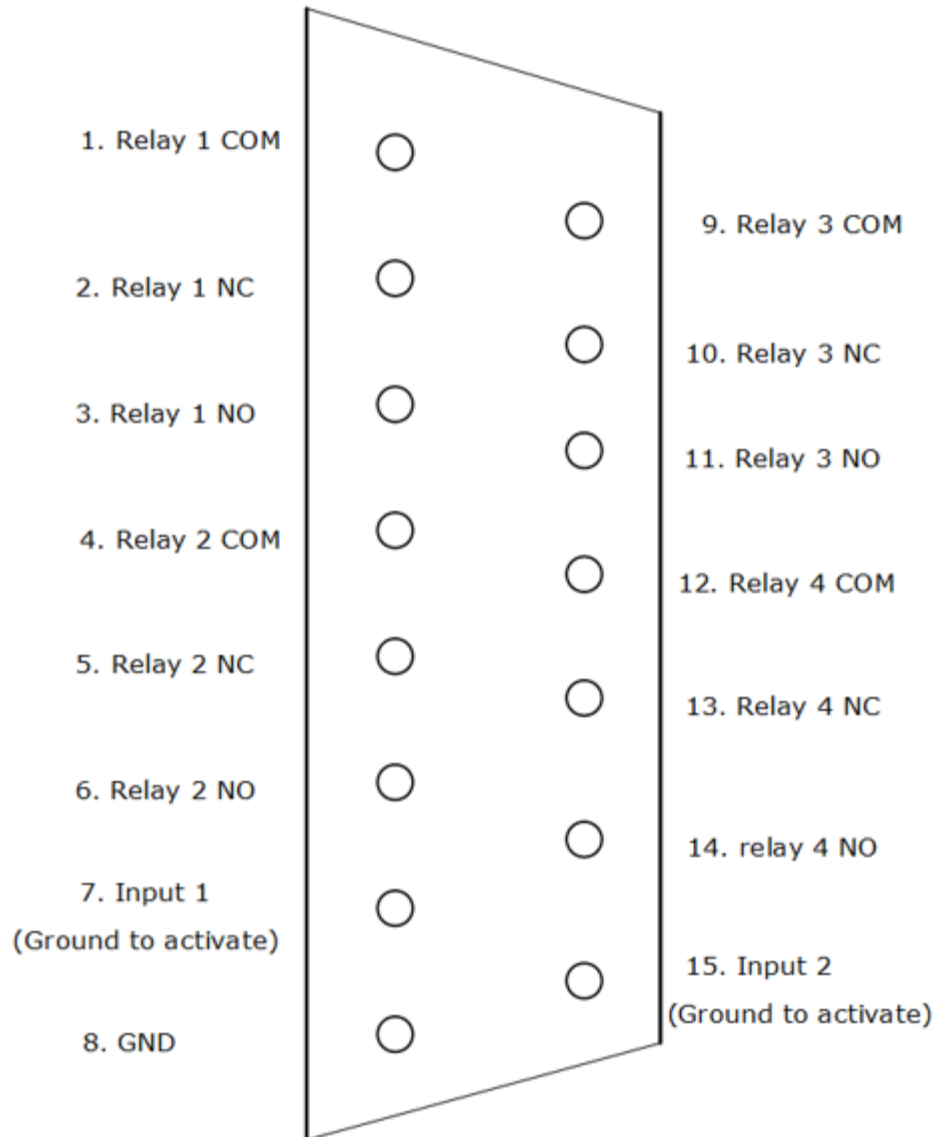

Pin	Description
Pin 1	Relay 1 COM
Pin 2	Relay 1 NC
Pin 3	Relay 1 NO
Pin 4	Relay 2 COM

Pin	Description
Pin 5	Relay 2 NC
Pin 6	Relay 2 NO
Pin 7	Input 1 (Ground to activate)
Pin 8	GND
Pin 9	Relay 3 COM
Pin 10	Relay 3 NC
Pin 11	Relay 3 NO
Pin 12	Relay 4 COM
Pin 13	RELAY 4 NC
Pin 14	RELAY 4 NO
Pin 15	Input 2 (Ground to activate)

2.6 FreeSpeak II Base Station menu 'at-a-glance' guide

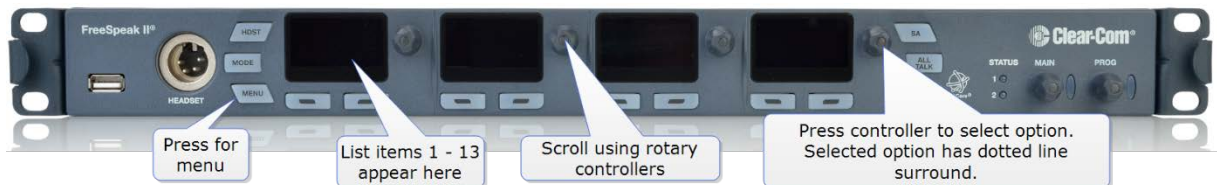

2.6.1 Audio Settings:

- Headset
- Program input
- Stage announce

2.6.2 Station settings:

- Program audio on Base Station Keysets (1-4)
- Display settings
- Make Base headset a Group Member (listen to group announcements)

2.6.3 Channels

- Change Channel name (label)

2.6.4 Groups

- Change Group name (label)

2.6.5 4-wire audio

- Program audio for 4-wire (Ports 1-4)

2.6.6 2-wire audio, A and B, C and D.

- Program audio for 2-wire (Ports A and B, C and D)

2.6.7 Key Assign

- Select each beltpack (Role) and program/edit audio on keys (A, B, C, D)

2.6.8 Beltpacks

- Change beltpack Role
- Unregister beltpacks
- Check beltpack software version
- Fix beltpack Role

2.6.9 Roles

- Create, clone and delete Roles
- Edit Role settings, e.g. change channel, alter volume, set menu access etc.

2.6.10 Antennas

- Change antenna name (label)
- Set cable compensation if required

2.6.11 Networking

- Station id (name)
- DHCP or Static IP
- Base station IP address

2.6.12 Administration

- Beltpacks: start over-the-air registration
- Software: View version and upgrade
- License: View license and upgrade
- Reset to factory settings and save/restore settings
- Change menu access pin code
- Set AA battery type

2.7 Networking/IP issues

2.7.1 Dynamic Host Configuration Protocol

The FreeSpeak II Base is set to DHCP by default. For fast set-up, DHCP is the best option to use as the Base Station can be immediately connected to any network which provides DHCP. Most networks allocate IP addresses using DHCP. The addresses provided are dynamic and will change from time to time.

2.7.2 Static IP configuration

If your intercom installation becomes permanent, obtain a static IP address to avoid the Base IP address from changing periodically.

When linking multiple Bases across a network or networks static IP addressing is essential. Your network administrator should provide details.

2.7.3 Netmask or subnet

The netmask or subnet divides the network into sectors for more efficient routing and is required when allocating a static IP address to a Base Station. Your network administrator should provide details.

2.7.4 Gateway

This setting is optional. It is required if your system navigates across subnets (as might be the case when accessing the CCM across networks, or linking systems). If not explicitly stated, Gateway will revert to the device IP address.

2.7.5 Set static IP details for Base Station

From the CCM:

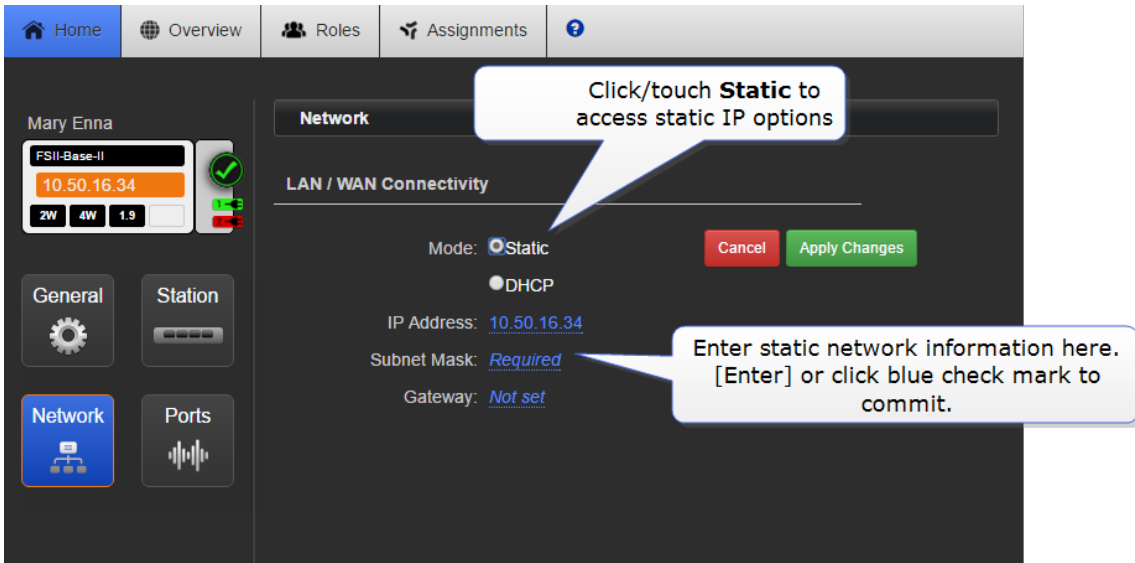

From the Base Station

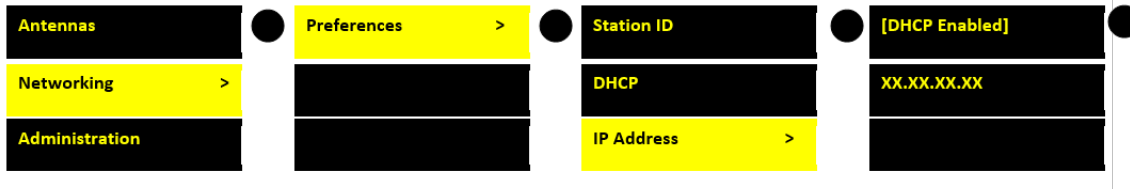

Press **MENU** button on front of Base for menu mode. Navigate menus using rotary controllers.

Disable DHCP:

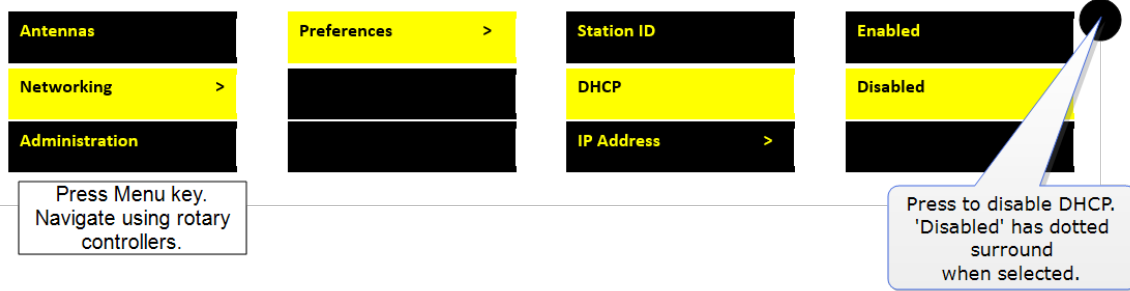

Enter static IP address

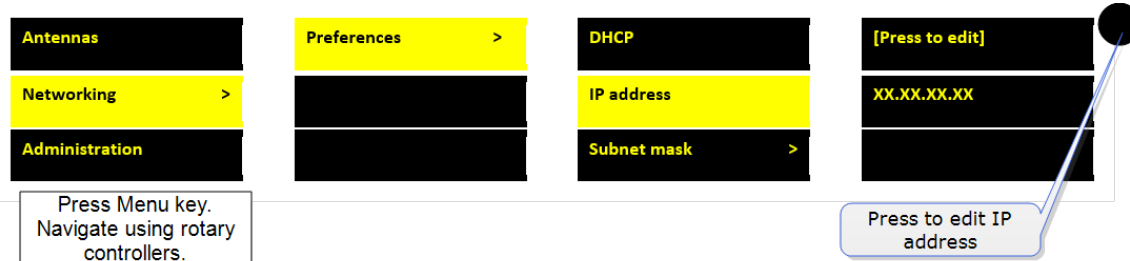

Edit subnet and gateway details as required.

Find the IP address in the front menu screens of your device.

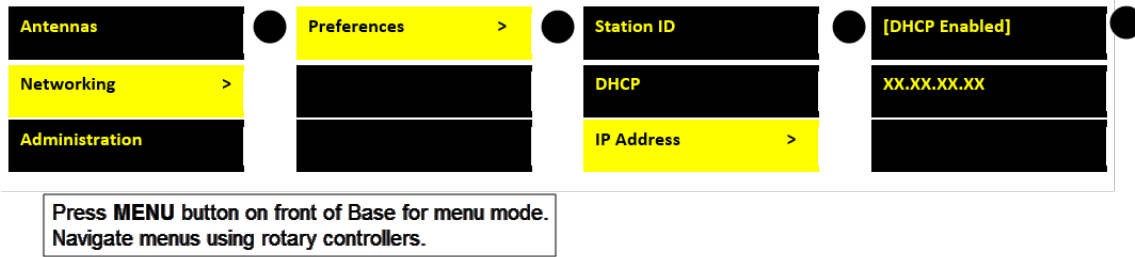

Note: If you are having trouble connecting to the CCM for your Base Station, one possibility is an IP clash (two devices attempting to use the same IP address).

2.8 Base Station menu overview

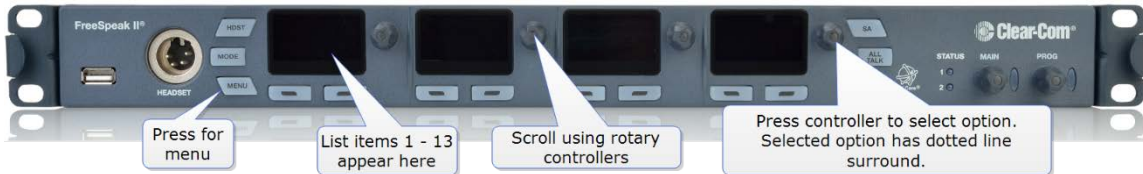

List item Description

1. Audio Settings:

- Headset
- Program input
- Stage announce

2. Station settings:

- Program audio on Base Station Keysets (1-4)
- Display settings

3. Channels

- Change Channel name (label)

4. 4-wire audio

- Program audio for 4-wire (Ports 1-4)

5/6 2-wire audio, A and B, C and D.

- Program audio for 2-wire (Ports A and B, C and D)

6. Key Assign

- Select each beltpack (Role) and program/edit audio on keys (A, B, C, D)

7. Beltpacks

- Change beltpack Role
- Unregister beltpacks
- Check beltpack software version

8. Roles

- Create, clone and delete Roles

9. Antennas

- Change antenna name (label)
- Set cable compensation if required

10. Networking

- Station id (name)
- DHCP or Static IP (DHCP recommended)
- Base station IP address

11. Administration

- Beltpacks: start over-the-air registration
- Software: View version and upgrade
- License: View license and upgrade

3 *Installing the antennas*

3.1 Introduction

Each FreeSpeak II Base has capacity for 25 beltpacks and up to 10 antennas (using two splitters). You need to place antennas to create a custom coverage zone to suit your requirements, taking into account the physical environment and beltpack user needs.

Typical FreeSpeak Configurations

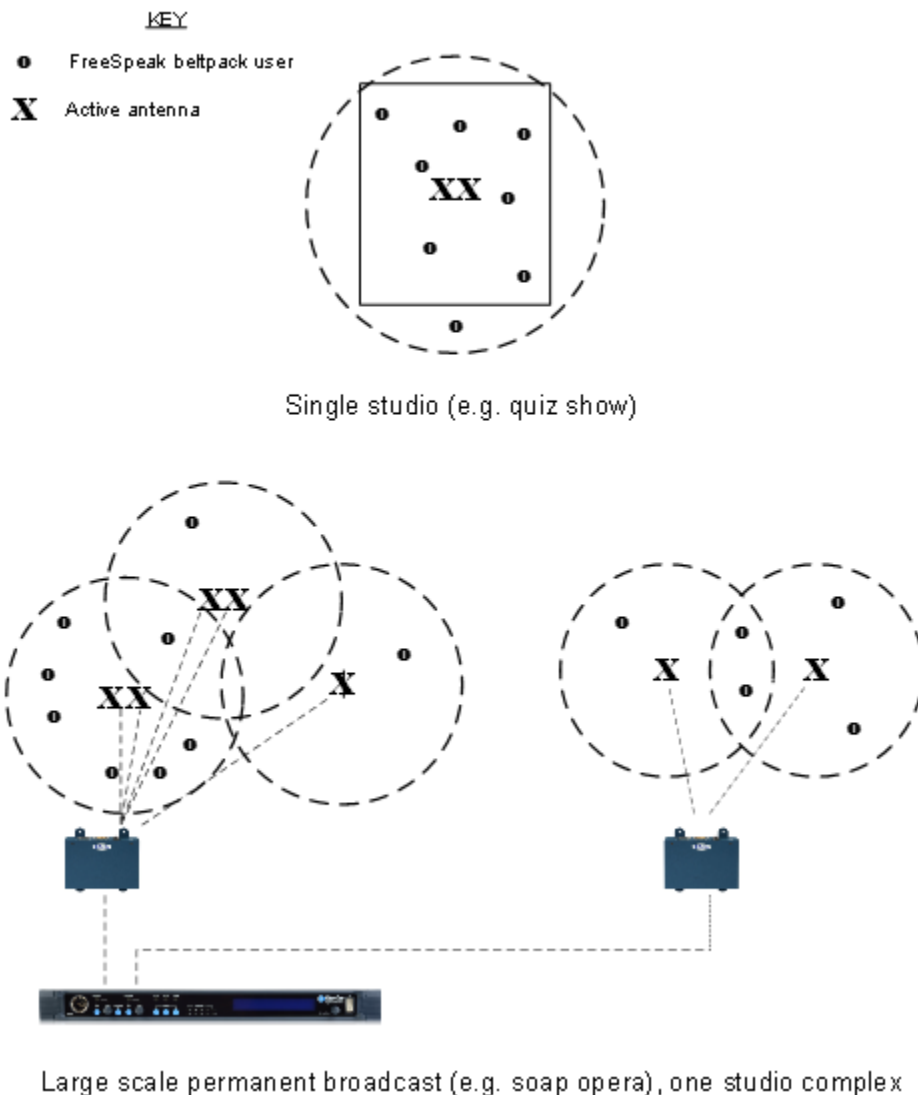

Things to take into account include:

- Consider both capacity and coverage. How many beltpack users are there and what are their movements? Ensure that you have enough capacity where users congregate, as well as allowing for coverage area.
- What are the individual characteristics of your site? Radio waves can be reflected by metallic objects, and reduced by some objects, including the human body (for instance, a large audience can affect transmission).
- What conduit (cabling) is already available on site? Are there power points? Splitters must be powered locally, and Clear-Com recommends powering antennas locally.
- As a general rule, antennas should be placed 8 – 10 feet high (2.5 – 3 meters high).
- When co-locating antennas for extra beltpack capacity in one area, do not put the devices too close to each other. They should be placed between 3 and 20 feet (1 - 7 meters) apart.
- FS II antennas can be placed at any orientation.

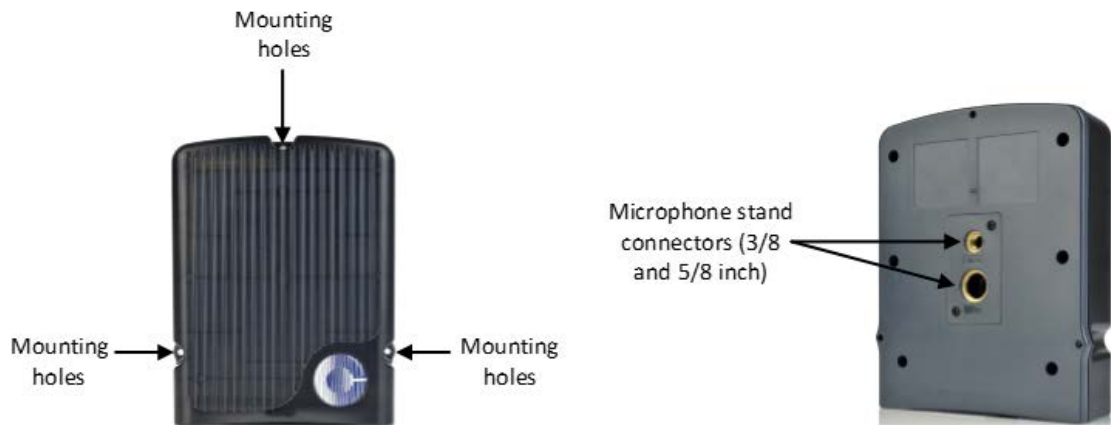

- Antennas have an IP (International Protection) rating of 65. This means they can be mounted outside and will be weather-proof.

3.1.1 Antenna capacity (how many beltpacks?)

Clear-com recommends a conservative approach to antenna capacity, to ensure coverage and allow for system losses.

- 1.9 GHz : 3 - 4 beltpacks per antenna
- 2.4 GHz: 2 - 3 beltpacks per antenna.

3.1.2 Antenna coverage (how far?)

Antennas provide circular (omnidirectional) coverage.

In ideal conditions, an antenna range can go up to 500 meters (1640 feet). However, an average range, taking into account objects and conditions that impede radio waves, is between 50 - 150 meters (164 - 490 feet).

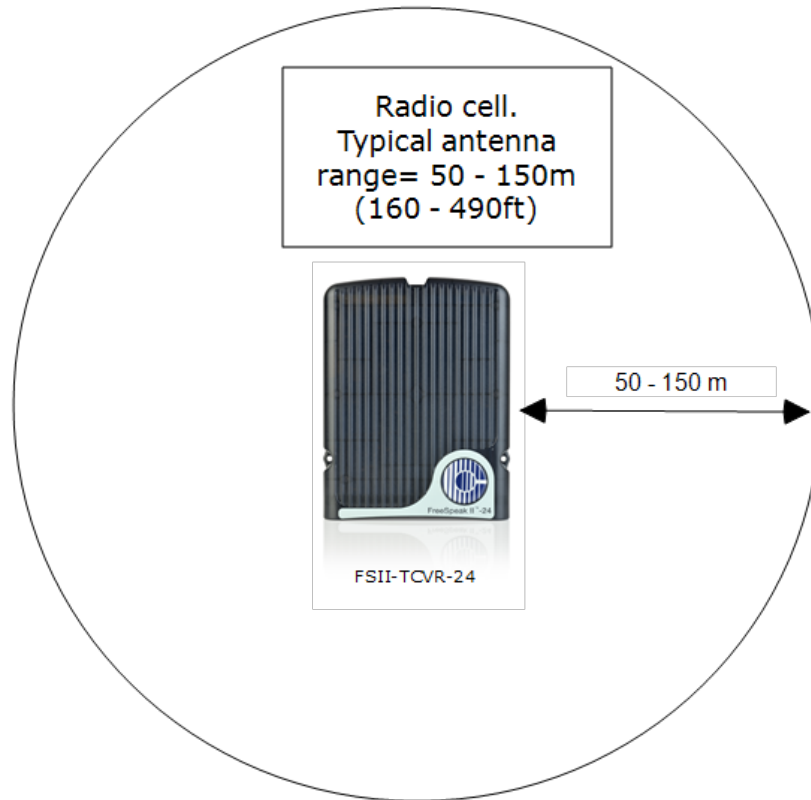

3.1.3 Possible distance from Base Station to antenna

The Base Station can power 1 antenna to a distance of 300 meters (984 feet). More than one antenna and/or greater distances will need direct power supplied to the antenna.

The figures in this table are based on the use of 24AWG Cat5/6 cable	Capacity (distance and no. of devices)
Base to antenna. No PSU at antenna.	1 antenna only. 300 meters (984 feet).

Base to antenna. PSU at antennas.	2 antennas. 800 meters (2625 feet).
Base to splitter. Splitter must have PSU.	800 meters (2625 feet).
Splitter to antenna. Antennas powered by splitter, no PSU at antenna.	5 antennas. 300 meters (984 feet)
Splitter to antenna. PSU supplied to antennas.	5 antennas. 800 meters (2625 feet).

Note: Connecting devices over Fiber will increase potential distances from Base to antenna.

It is advisable to place antennas temporarily until coverage has been tested. Once antennas have been temporarily placed, test the coverage zone by putting a beltback in **Site Survey** mode and walking through the area monitoring signal strength.

3.2 Site survey

A site survey involves temporary placement of antennas while testing coverage (area covered by radio frequency) and capacity (how many beltbacks can be supported) by the system.

After placing the antenna(s) in a temporary way, a beltback user walks through all the areas where beltback users will typically be moving, noting any areas of weak signal, dropout, or disconnection of the system.

For extensive or complicated systems, it is helpful to draw a map of the area with antenna placement and corresponding RF cells. For a smaller system, just testing one antenna in **Standalone** mode may be sufficient.

To test coverage areas, put the beltback into **Site Survey** mode.

- How to put a beltback into Site Survey mode.
- Interpreting the Site Survey screen
- "Standalone site survey"

3.2.1 Antenna coverage zone

Antenna coverage zone = area where

- $RSSI \Rightarrow 30$

- Link Quality => 3

for all beltpacks.

Adjust antenna placement to get the best coverage. Coverage zones should be overlapped. Example coverage zones are shown below.

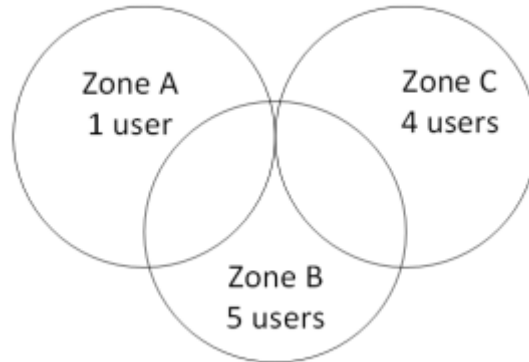

3.3 Standalone site survey

You might need to scope a site (check the range and performance of an antenna) without connecting to a Base Station. To do this a beltpack and antenna can be connected in Standalone mode.

Make sure you have to hand:

- A powered beltpack
- An antenna
- A DC in XLR (male) power connector for the antenna
- Access to a power socket.

3.3.1 Setting standalone mode

To establish **Standalone** mode on an antenna:

1. Connect power cable and press **mode** button **at the same time**.

2. Amber signal light will flash when device is in **Standalone** mode.



3. When amber LED is flashing, a beltpack can be connected/ paired to the antenna in order to be able to see details of the antenna's radio frequency (RF) coverage.

- 1) Connect power to the antenna and at the same time press the black Mode button on the base of the antenna. This puts the antenna in standalone mode, and opens it for pairing to a beltpack.

Note: The amber LED flashes continuously to show that the antenna is open for pairing with a beltpack in standalone mode.

- 2) Holding the beltpack, press the Menu key (2 second press) and navigate to System Connect using the right hand rotary controller on the beltpack.
- 3) Press button D to see local systems available for connection.

Note: In menu mode the D key on the beltpack operates as SELECT and the C key exits the menu level and cancels the selection.

- 4) Scroll through available systems using the right hand rotary controller.
- 5) When you have found the antenna to pair to (it will be showing a 'P' to indicate that it is open for pairing) press button D to select the antenna and connect the beltpack to it.
- 6) When the beltpack is successfully connected to the antenna, navigate to Site Survey in the beltpack menu and monitor the range and performance of the antenna. See Interpret the Site Survey Screen below.

3.4 Using an antenna with a Fiber connection

3.4.1 Install Fiber modules (parts HLI-SMFO, HLI-MMFO)

You may wish to connect a FreeSpeak II Base to a splitter (FSII-SPL) using Fiber. In this case, you need to install Fiber modules to the Base and the splitter.

- Modules are available for single mode Fiber cable (HLI-SMFO) and multi-mode Fiber cable (HLI-MMFO)
- Modules are supplied as a pair, one for the Base Station and one for the splitter.
- The Base Station switches between Fiber and RJ45 mode automatically, depending on which connector (Fiber or RJ45) is used
- Modules can be hot patched, no need to power off devices.

Install Base Station Fiber module.



Slide module into Fiber connector port.
(Remove dust cap)

Install splitter Fiber module.

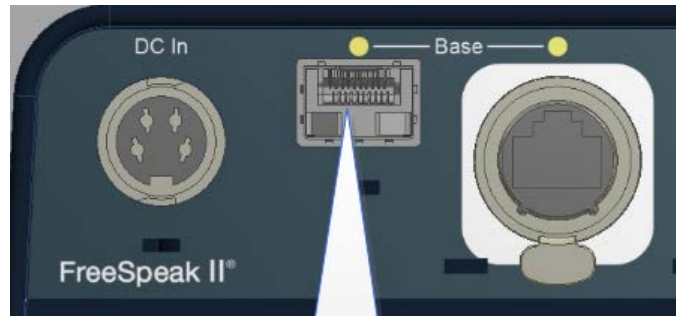

Insert Fiber module

Once the modules are installed, the Base Station and the splitter can be cabled with the correct Fiber cable (single mode or multi-mode depending on existing cabling). You will see the Base Connection indicator on the front of the splitter change from RJ45 to Fiber.

3.5 Interpreting the Site Survey screen

The four numbers on this screen represent, from left to right: Antenna, RSSI (Received Signal Strength Indication), FER (Frame Error Rate) and Link Quality (this figure is a calculation based on RSSI and FER).

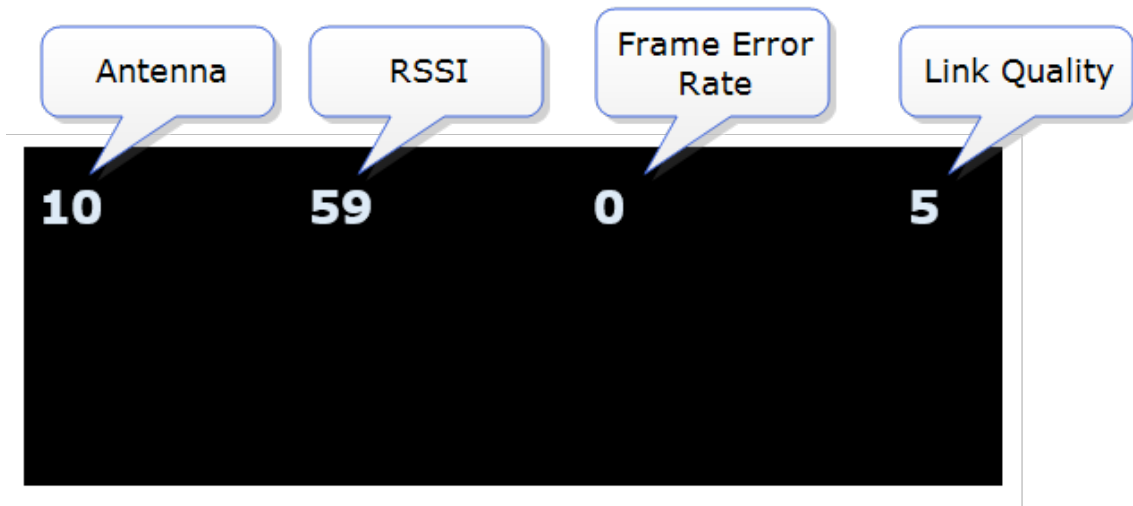

3.5.1 Antenna coverage zone

The antenna coverage zone is the area where:

- RSSI => 30
- Link Quality => 3

FER should be as close to 0 as possible.

Below these figures, the beltacks may start to lose audio. All beltacks in the system must have sufficient ratings.

Note: You can press the Mode button on the front of the Base Station to check antenna performance at any time.

3.6 How to put a beltack into Site Survey mode

- 1) The beltack must have advanced menu access (set menu access in **Roles/Beltack Role/Menu Access** from Base Station menus or the CCM).
- 2) Press and hold the **Menu** button on the beltack for 2 seconds to enter menu mode.
- 3) Navigate to **Site Survey** in the Master menu using rotary controllers to scroll through menu options. Site survey is at the bottom of the Master menu.
- 4) Press **D** key to select Site Survey. Use **C** key to go back or cancel.

3.7 Cable compensation

You must set cable compensation if the total cable length between antennas is greater than 500m/1640 feet.

3.7.1 About cable compensation

Cable length needs to be calculated when the distance in total cable length between antennas is greater than 500m/1640 feet. This is to prevent the DECT signals between antennas from becoming out of synchronization. If the antennas are not synchronized, beltpack handover will not happen effectively.

Setting cable compensation is particularly important if you have overlapping antenna coverage zones (RF cells) or the beltpacks need to move between coverage zones.

Example

Antenna 1: total cable length = 300m/984 feet.

Antenna 2: total cable length = 850m/2788 feet.

In this case, antenna cable length should be set.

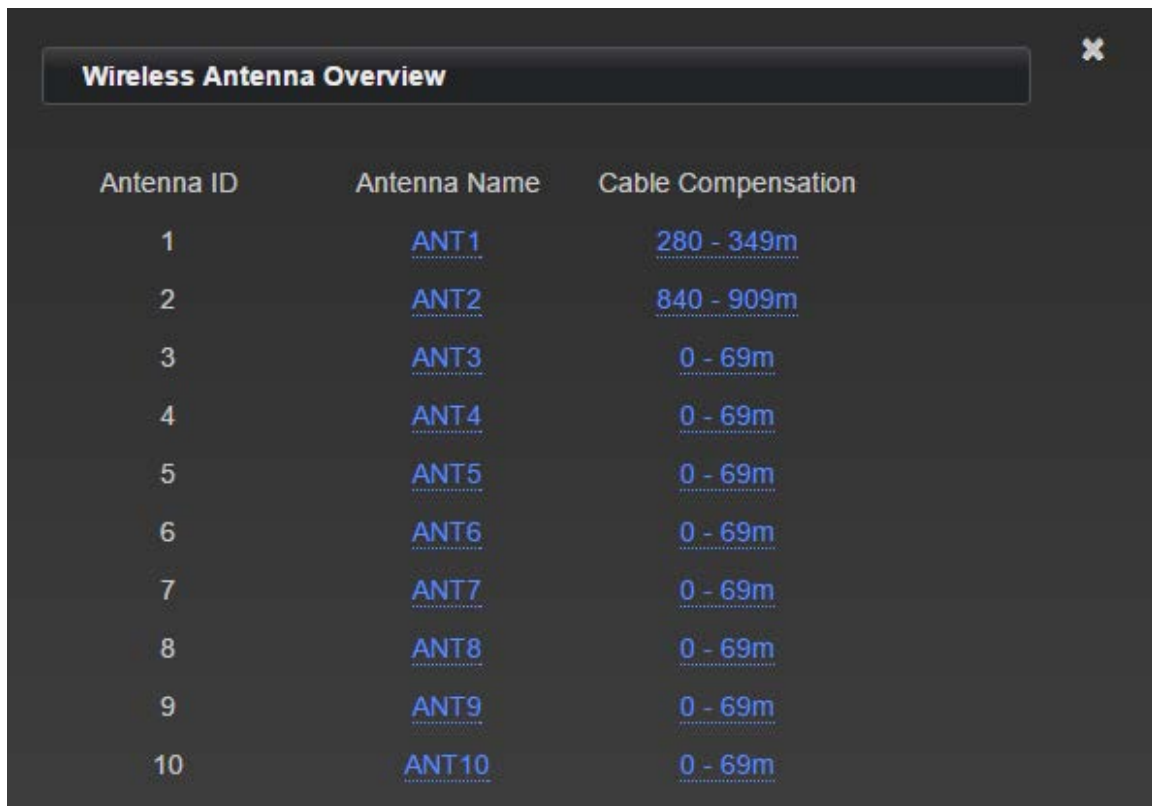

The screenshot shows a 'Wireless Antenna Overview' window with a table listing 10 antennas. The table has three columns: 'Antenna ID', 'Antenna Name', and 'Cable Compensation'. Antenna 1 has a cable compensation range of 280 - 349m, while antennas 2 through 10 have a range of 0 - 69m.

Antenna ID	Antenna Name	Cable Compensation
1	ANT1	280 - 349m
2	ANT2	840 - 909m
3	ANT3	0 - 69m
4	ANT4	0 - 69m
5	ANT5	0 - 69m
6	ANT6	0 - 69m
7	ANT7	0 - 69m
8	ANT8	0 - 69m
9	ANT9	0 - 69m
10	ANT10	0 - 69m

How to set cable length in the CCM: 1.

Home Overview Roles Assignments Clear-Com

Wireless Beltpacks

Antenna Configuration

Role	Status	1 (ep) ANT1	2 (ep) ANT2	3 (ep) ANT3	4 (ep) ANT4	5 (ep) ANT5	6 (ep) ANT6	7 (ep) ANT7	8 (ep) ANT8	9 (ep) ANT9	10 (ep) ANT10
FSBP 1											
FSBP 2											

Other Registered Beltpacks

ID	Role

Wireless Antenna Overview ✕

Antenna ID	Antenna Name	Cable Compensation
1	ANT1	0 - 69m
2	ANT2	0 - 69m
3	ANT3	0 - 69m
4	ANT4	0 - 69m
5	ANT5	0 - 69m
6	ANT6	0 - 69m
7	ANT7	0 - 69m
8	ANT8	0 - 69m
9	ANT9	0 - 69m
10	ANT10	0 - 69m

Click to close window

Click here to set antenna cable length. [Enter] key or blue check mark to save changes.

Click here to re-name antenna. [Enter] key or blue check mark to save changes.

How to set cable length from the Base menus:

Press **Menu** key on the Base.
Use rotary controllers to navigate.

Push to select. Selected item has dotted surround.

4 Using the antennas

4.1 Introduction

The antennas provide a customizable network of coverage zones in which beltpacks can operate. Beltpacks can roam freely between zones.

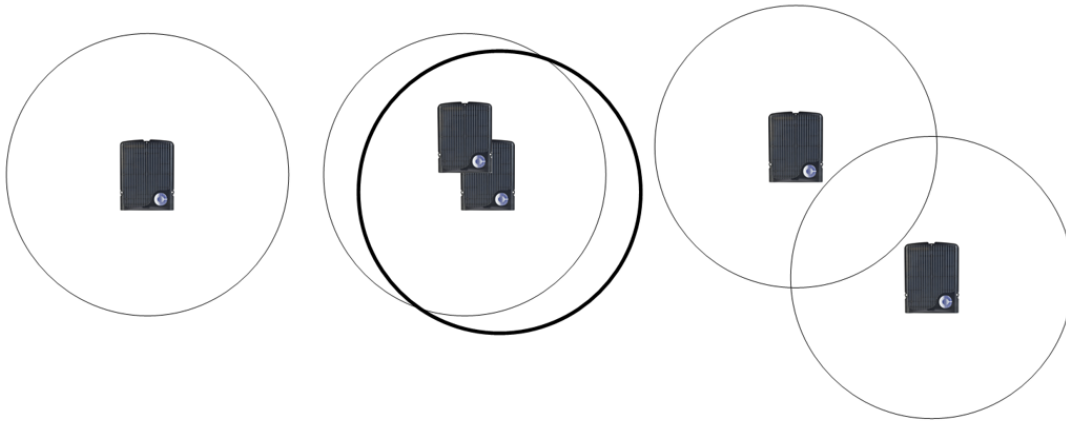

- Each antenna covers a certain range or cell size. Maximum line-of-sight range up to 500m (1640 ft)
- Typical range 50 – 150 m (160 – 490 ft)
- Full duplex users (beltpacks) per antenna: 1.9 GHz, 3 users, 2.4 GHz 4 users.

- If two or more antennas are placed in the same area the cell size is the same
- However, cell density has increased to handle up to 8 users

- If antennas are placed across the site then this increases radio coverage area
- Beltpacks can roam from one antenna to another and stay in constant communication

Antennas can be mounted flat on a wall or using a microphone stand.



4.1.1 Antenna capacity (how many beltacks?)

Clear-com recommends a conservative approach to antenna capacity, to ensure coverage and allow for system losses.

1.9 GHz : 3 - 4 beltacks per antenna

2.4 GHz: 2 - 3 beltacks per antenna.

4.1.2 IP rating (international protection marking)

The antenna has an IP rating of 65 so it can be mounted outside and will be resistant to weather conditions.

4.2 Antenna connectors

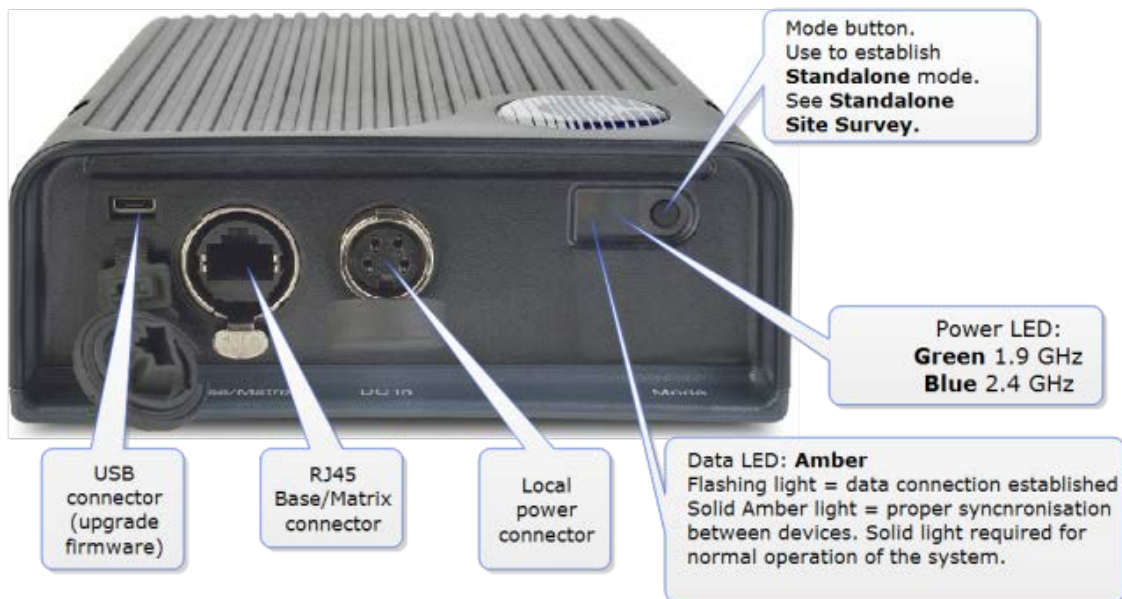

4.3 FreeSpeak II Base 1.9 GHz/2.4 GHz



The two sets of equipment can be used separately or together.

Which frequency you use affects how many belt packs can be used in any one radio frequency (RF) cell (the range of one antenna).

Each antenna is designed to handle 5 belt packs in the 1.9 GHz range and 4 belt packs in the 2.4 GHz range, simultaneously and in good conditions. If interference or propagation problems occur in an area, it may be practical to install one less belt pack for each antenna.

For most working systems, Clear-Com uses a ratio of 3 - 4 (1.9 GHz) or 2-3 (2.4 GHz) users per antenna. This is due to system losses.

4.4 Radio frequency (RF) issues

When using system diagnostics and the site survey screen you will interpret RSSI, FER and Link Quality.

As a general rule, Received Signal Strength (RSSI) \Rightarrow 30. Frame Error Rate (FER) should be as close to 0 as possible, and Link Quality should be \Rightarrow 3.

4.4.1 High frame error rate (FER)

You may have a situation where RSSI is high, but FER is also high, giving a low overall Link Quality. Potential causes of this kind of interference are:

- There is another RF device in the area. This can be tested using a band monitor or spectrum analyser.
- There are reflective surfaces in the area causing Long Delay Spread Multipath interference. This kind of interference is improved by careful antenna placing, to avoid signal reflection. You may need advice from your Clear-Com representative in this situation.

4.4.2 National radio carrier frequencies

The carrier frequencies allocated for a radio space vary according to location. This affects the amount of beltpacks that can be supported in one RF cell.

Location	Number of carrier frequencies	Maximum beltpacks in one RF cell
United States	5	25 beltpacks
European Union and elsewhere	10	50 beltpacks

5 Using the FreeSpeak II Splitter (FSII-SPL)

5.1 Introduction

The FreeSpeak II Base antenna splitter is a device that connects up to 5 antennas to a FreeSpeak Base (both FreeSpeak I and FreeSpeak II, 1.9 and 2.4 systems) or an Eclipse matrix. Using the splitter, audio can be routed from the Base to antennas either via Cat5/6 Ethernet cable (RJ45) or a Fiber connection.

Using a splitter with Cat5/6 RJ45 connection

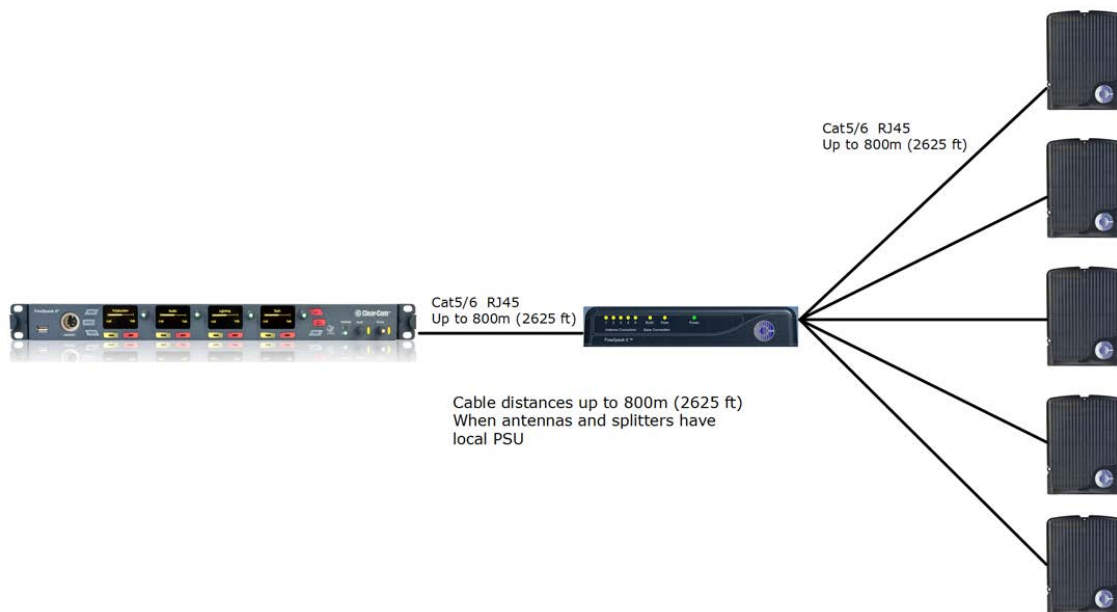

Using a splitter with Fiber connection.

Typical FSII-Base/FSII-splitter configurations using Clear-Com equipment

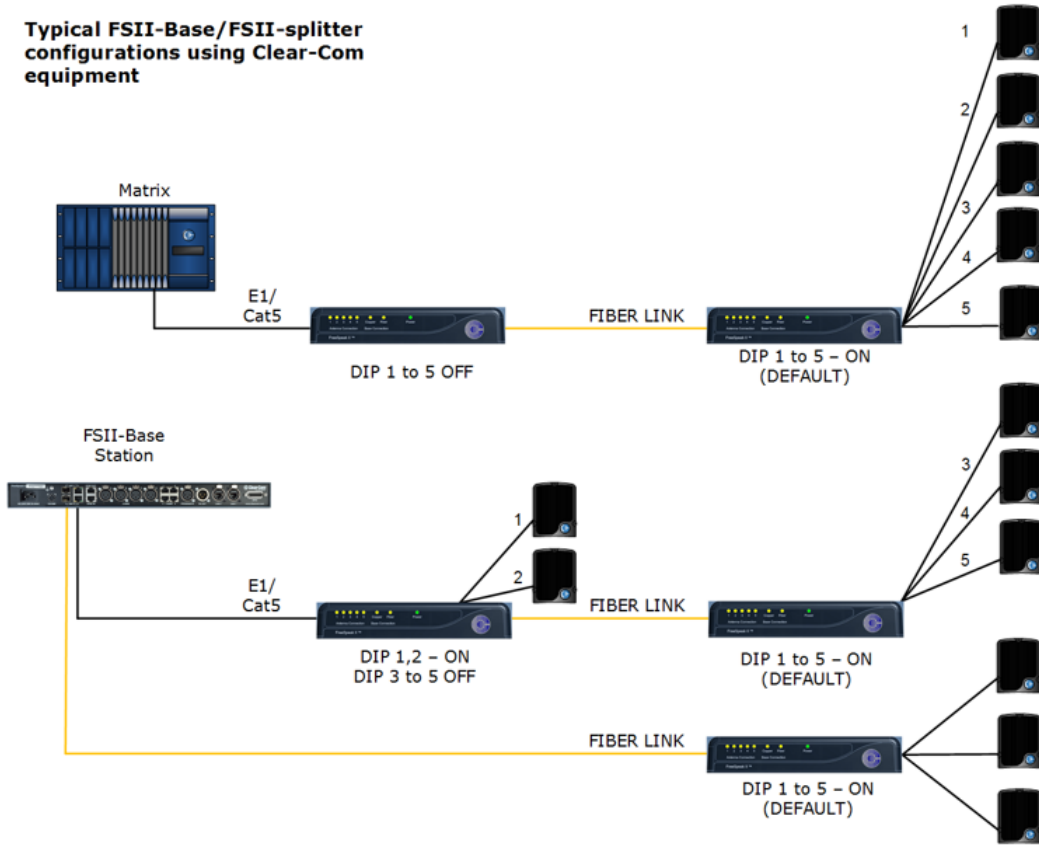

Typical system configuration using third party equipment

Note: In this configuration, there is no DECT Synchronization from the Base Station or matrix (DIP 6 - OFF). Only local DECT synchronization is possible.

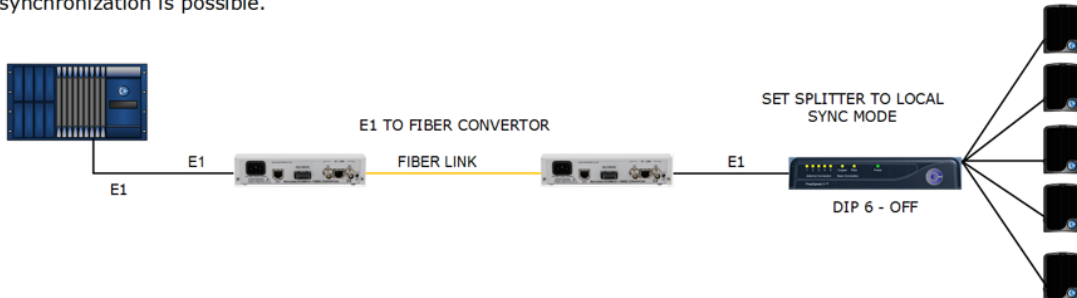

The antenna connections are switched between RJ45 and Fiber routing using dip switches set inside the splitter.

DIP switch settings (default in **BOLD**)

1 to 5	Antenna ports 1 to 5 ON - Active OFF - Convert to Fiber
6	ON - Base Sync OFF - Local Sync
7	If 6 is switched to OFF ON - FreeSpeak II OFF - FreeSpeak I
8	ON - Update OFF - Normal operation

To access the DIP switches, remove the covering panel on the base of the splitter (two screws).

Note: When you change a DIP switch setting, you must re-power the unit for the change to have any effect.

Note: When using Fiber, you must install Fiber modules.

Note: When using the splitter with third party routing devices, antenna synchronisation data is not passed. In this case, you need to set the splitter to 'local synch' mode.

5.2 Splitter front panel

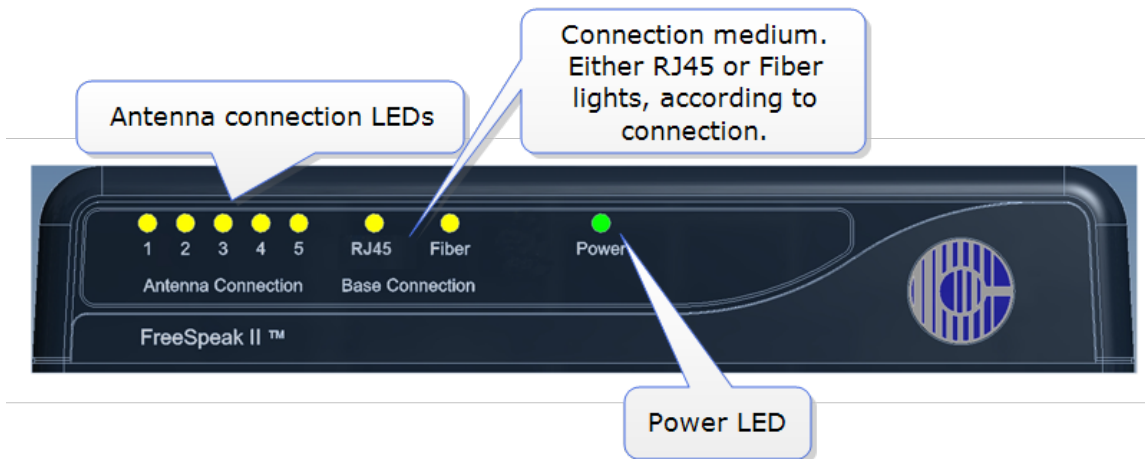

5.3 Splitter rear connectors

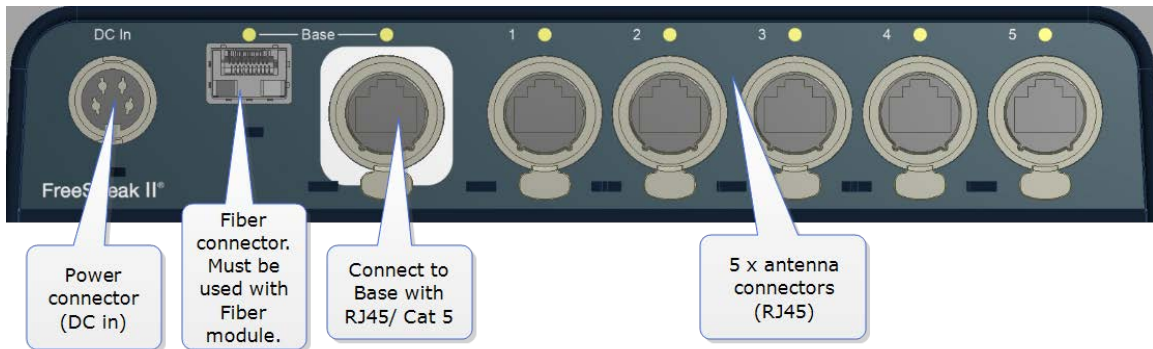

5.4 Splitter software version

Splitter software is not usually user upgradable, but if necessary you can find out the splitter software version (usually for system diagnostic purposes) by connecting to the splitter with a PC and using a serial console emulator such as Tera Term.

- 1) Remove the covering panel (two screws) on the base of the splitter to access a USB (micro) port next to the dip switch settings.
- 2) Connect the splitter to a PC using a USB A to micro B cable.
- 3) Allow windows to install a USB com port driver (this should be automatic).
- 4) Using a serial console emulator (such as Tera Term), input serial console settings.

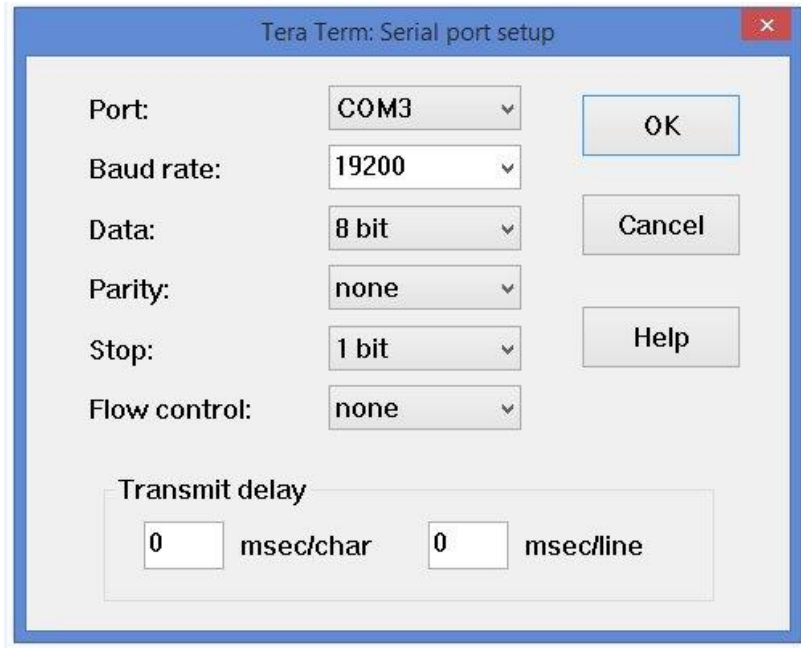

- 5) Open the serial console. Press the space bar and the splitter will output its software version as shown.

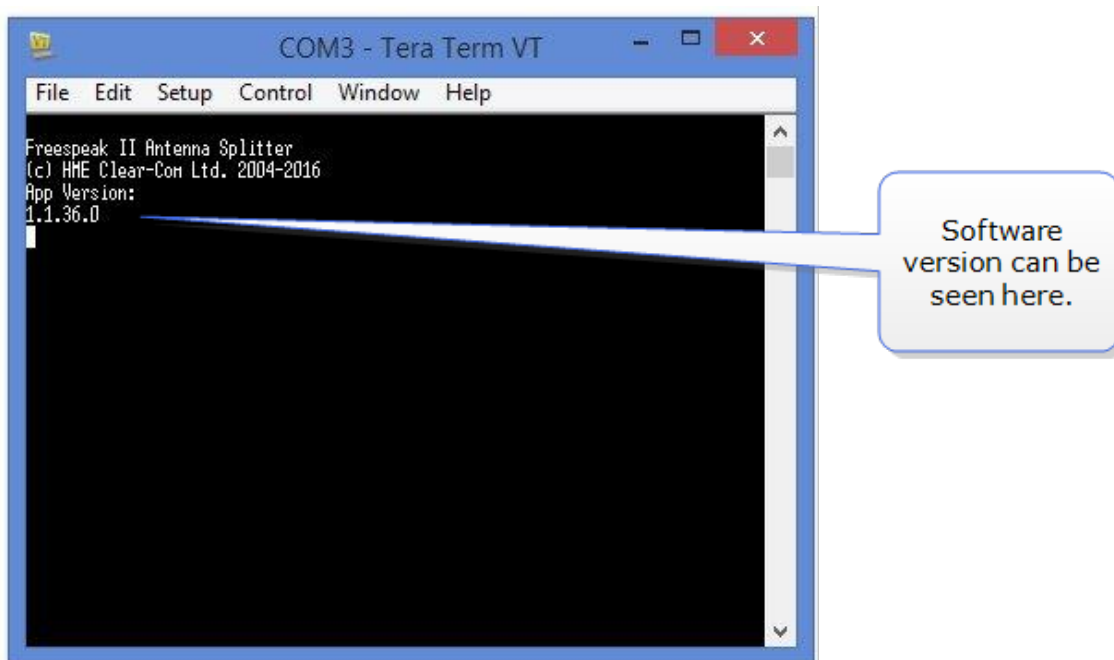

6 Using Beltpacks

Beltpacks are always configured using Roles. For more information, see **8 Roles**.

6.1 Registering Beltpacks

Wireless beltpacks must be registered to your Base Station before you can use them with the antennas.

Roles must be available for beltpacks before you register them. Your system arrives with default Roles which can be used, or you can create your own.

There are two ways of registering beltpacks:

- Registering beltpacks using USB cable
- Register beltpacks over-the-air (OTA).

Registering by USB cable is the quickest and easiest way.

6.1.1 Registering beltpacks using USB cable

You must have a USB A to micro USB B cable and the beltpacks to hand before you start.

- 1) Connect a beltpack to the Base Station using a USB A to micro USB B cable.

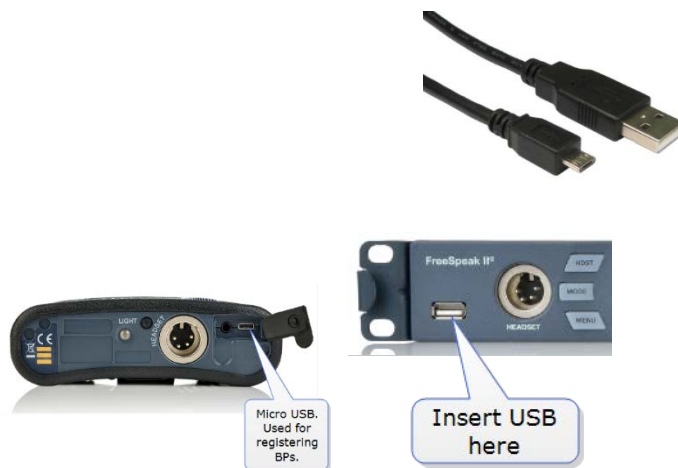

The beltpack can be powered on either before or after connection.

The Base Station will show 'Beltpack is now registered' in the front menu screens.

- 2) Select an available Role from the beltpack screen.

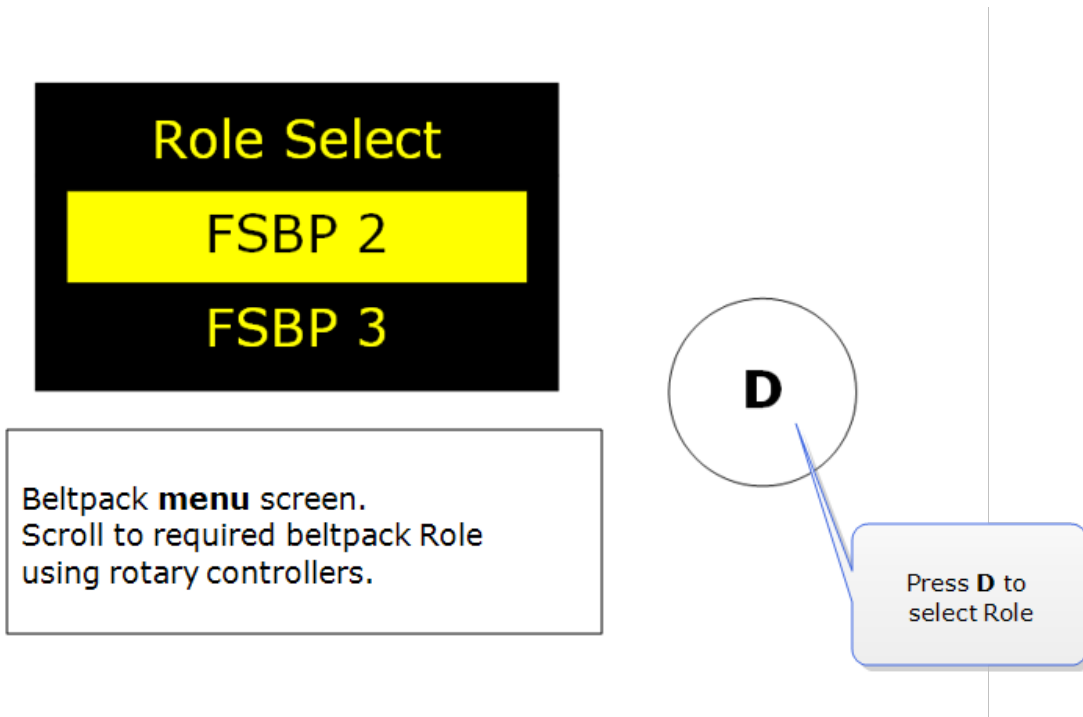

The beltpack is now registered and ready for use.

Note: A Role can be fixed to a beltpack. If you fix a Role to a beltpack, the beltpack automatically selects the Role on powering.

6.1.2 Registering Beltpacks over the air (OTA)

6.1.2.1 Start registration from the Base Station:

- 1) Press the **MENU** button on the base and navigate to: **Administration/Beltpacks/Over The Air/Start OTA**. Press the rotary controller to start registration.

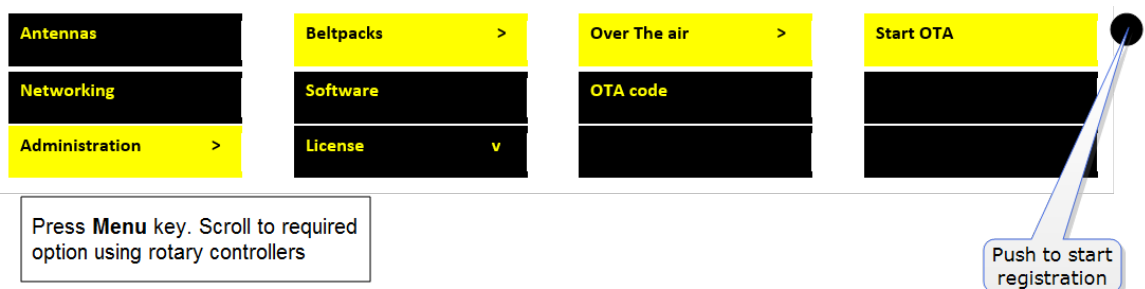

6.1.2.2 Start registration from the CCM

- 1) Connect to the CCM in a browser and navigate to **Home/General/Wireless**. Click the **OTA** button.

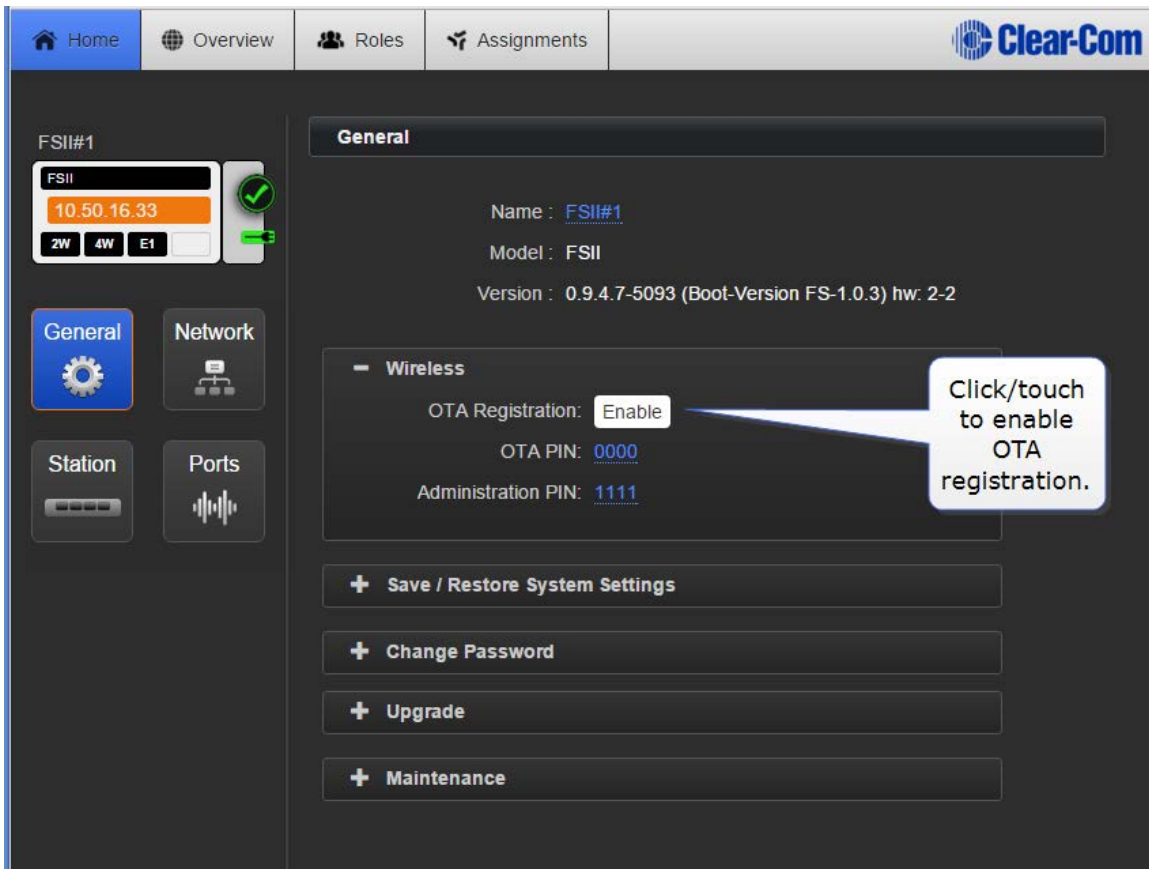

Note: Registration mode has a two-minute inactive time-out. This is so that several beltacks can be registered sequentially without having to re-enable registration mode.

6.1.2.3 Register Beltacks

Note: System = FreeSpeak II Base name.

- 1) On the beltack to be registered, hold the **Menu** key for two seconds to enter MENU options. Scroll to **SYSTEM CONNECT** using the rotary controllers and select it using key D. In menu mode the D key on the beltack operates as SELECT and the C key exits the menu level and cancels the selection.

Note: On a new system there will be no previous connections at this point. However, if the beltack is currently connected to an active system, a

confirmation screen will appear. Select Yes to connect to a new system or No to remain connected to the current system.

Available systems and previously registered systems will be visible on the beltpack menu screen.

To connect the beltpack to the system, the system must be visible (V) and in registration (pairing) mode. If the system is not in registration mode (P visible), registration should be re-started (Step 1).

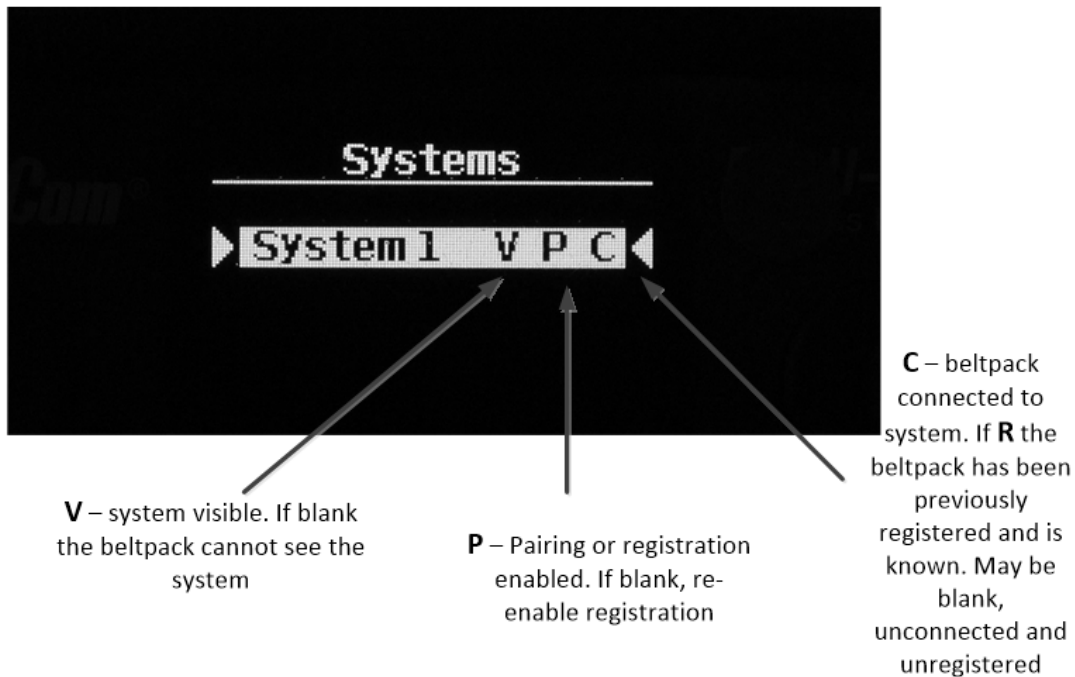

Connect the beltpack to the system using key D.

6.1.2.4 Enter pairing code

Enter the four-digit pairing code for the system using both rotary controllers and the menu select key (**D**). The default code is 0000.

Note: The O.T.A. pin code is available from the Base Station menus and the CCM. See **Administration/Beltpacks** on the Base Station, **Home/General/Wireless** in the CCM.

6.1.2.5 Select an available role from the list displayed on the Beltpack

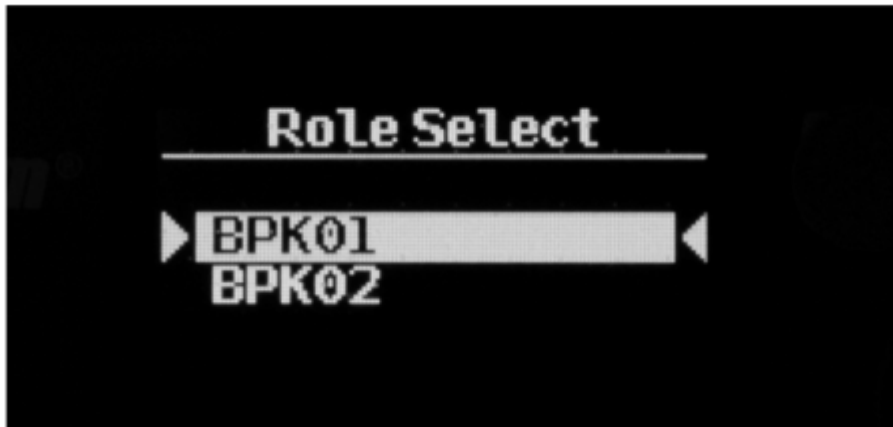

(Key D = SELECT)

The timer to enable registration is now re-started so another beltpack can be registered if required.

The beltpack is now registered and ready for use. If required another beltpack can be registered (step 2). A Role is associated with the beltpack until it is changed (from the CCM, Base Station menus or the beltpack itself). See **8 Roles**.

Note: All system changes are live.

6.2 Unregistering Beltpacks

Sometimes, you might want to unregister beltpacks from the Base. This is generally for housekeeping and security reasons. For example, you work with two separate studios that both use wireless beltpacks and need to be confidential.

Beltpacks can be unregistered from the Base either in the CCM or from the Base front menu screens.

From the CCM:

Home Overview Roles Assignments Clear-Com

Wireless Beltpacks

In the **Overview** page, click on the beltpack you wish to unregister.

Antenna Configuration (p)

ID	Role	Status	1 (p) ANT1	2 (p) ANT2	3 (p) ANT3	4 (p) ANT4	5 (p) ANT5	6 (p) ANT6	7 (p) ANT7	8 (p) ANT8	9 (p) ANT9	10 (p) ANT10
323594	FSBP 2	1h [Signal]	⊙									
000289	FSBP 3	9h [Signal]			⊙							
262148	FSBP 4	7h [Signal]	⊙									
000776	FSBP 5	7h [Signal]						⊙				

Other Registered Beltpacks

ID	Role

From the Base Station:

2W Audio (C / D)	FSII-BP-312 >	Version	Unregister now
Key Assign	FSII-BP-928	BP Type	
Beltpacks >	FSII-BP-944 v	Unregister	

Press menu key. Navigate using rotary controllers

Push to unregister beltpack

6.3 Assign channels to Beltpack keys

Audio assignment for beltpacks is always done with a Role. A Role is a pre-defined beltpack configuration map. You select a Role for a beltpack when it is first powered on. The Role a beltpack is using can be changed from the Base station, the CCM or the beltpack itself.

In the first case, it is easiest to use the default Role. This puts Channel 1 and Channel 2 on to the beltpack keys.

To change the Channel on a beltpack you need to edit the Role that beltpack is using. Find the beltpack Role name at the bottom of the beltpack screen:

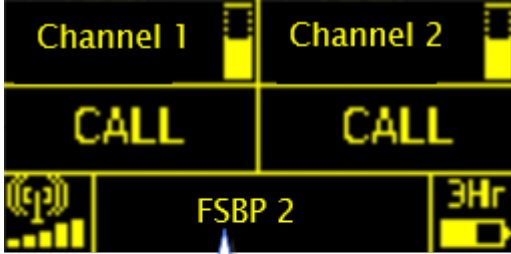

Beltpack Role name

Edit beltpack Role in the CCM.

Navigate to **Roles** page in the CCM

Select key

Select beltpack Role you wish to edit (selected Role has an orange highlight).

Click/touch here

A	B	C	D	REPLY
Channel 1	Channel 2	CALL	CALL	REPLY

Key Assignment : [Channel 1](#)

Key Behavior : [Talk & Force Listen](#)

Talk Latch : [Latching](#)

- + General Settings
- + Gain & Level Options
- + Headset
- + Menu Access
- + Alarm Options

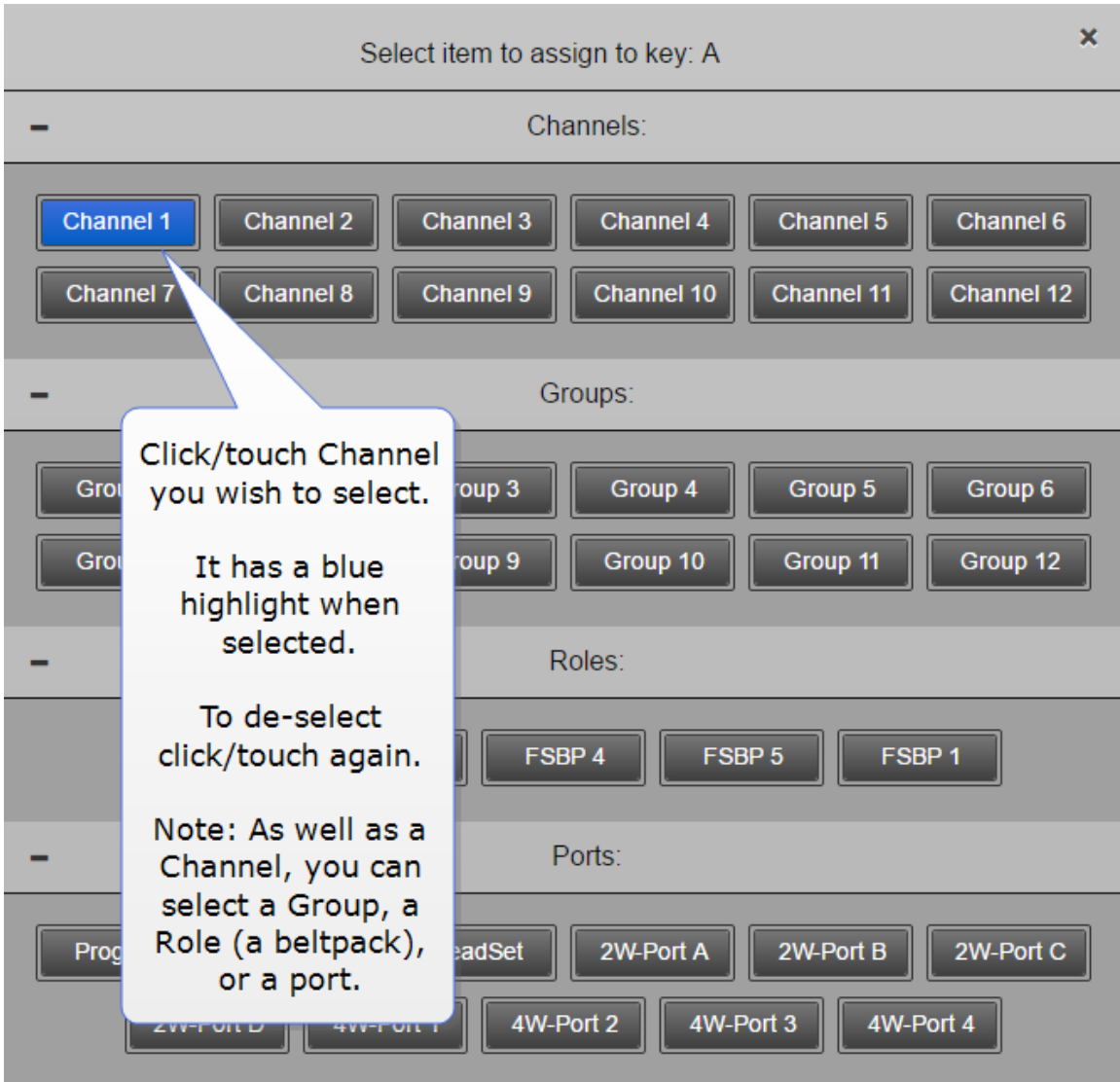

Edit beltpack Role from the Base Station menu screens.

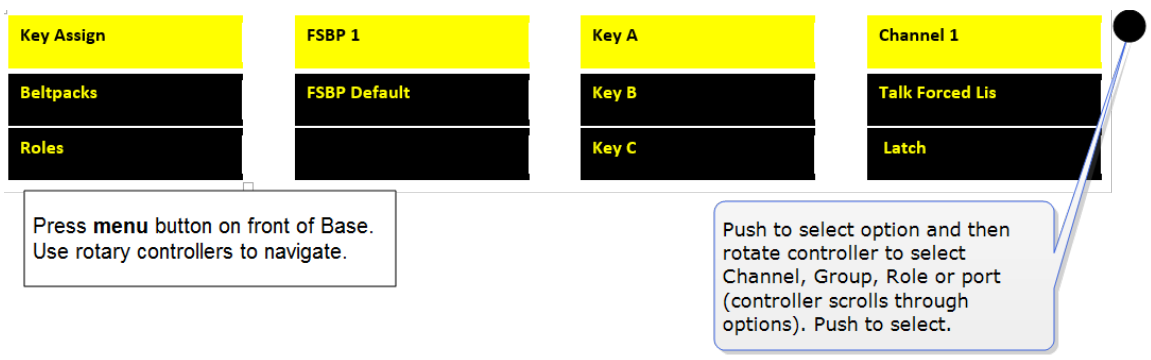

Press **menu** button on front of Base. Use rotary controllers to navigate.

Push to select option and then rotate controller to select Channel, Group, Role or port (controller scrolls through options). Push to select.

Note: You can assign audio to keys C, D and Reply. To return the status of these keys to Call and Reply, you must deselect or unassign the audio assignment.

A selected assignment turns blue in the CCM. Click on a blue assignment again to deselect it. From the Base Station menu screens go to Key Assign/Role/Key/Unassigned.

6.3.1 Key behavior

Keys can be set to different talk and listen states.

Key behavior can be set from the CCM or the Base Station.

Key behavior options	Resulting audio behavior
Talk	Press key to talk. Key only controls talk.
Listen	Press key to listen. Key only controls listen.
Talk and Listen	Press key to talk and listen.
Dual Talk and Listen	Press key to talk and listen. Listen latches on or off according to preference (quick tap to latch). User controls listen state.
Forced Listen	Permanent listen.
Talk and Forced Listen	Permanent listen, push key to talk.

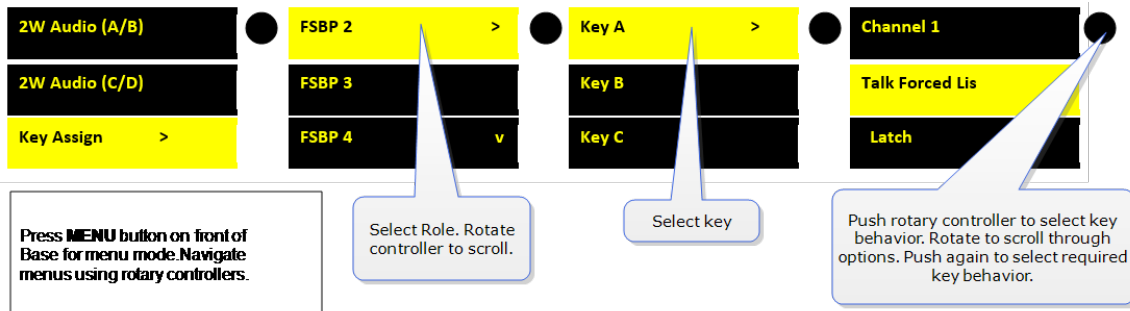
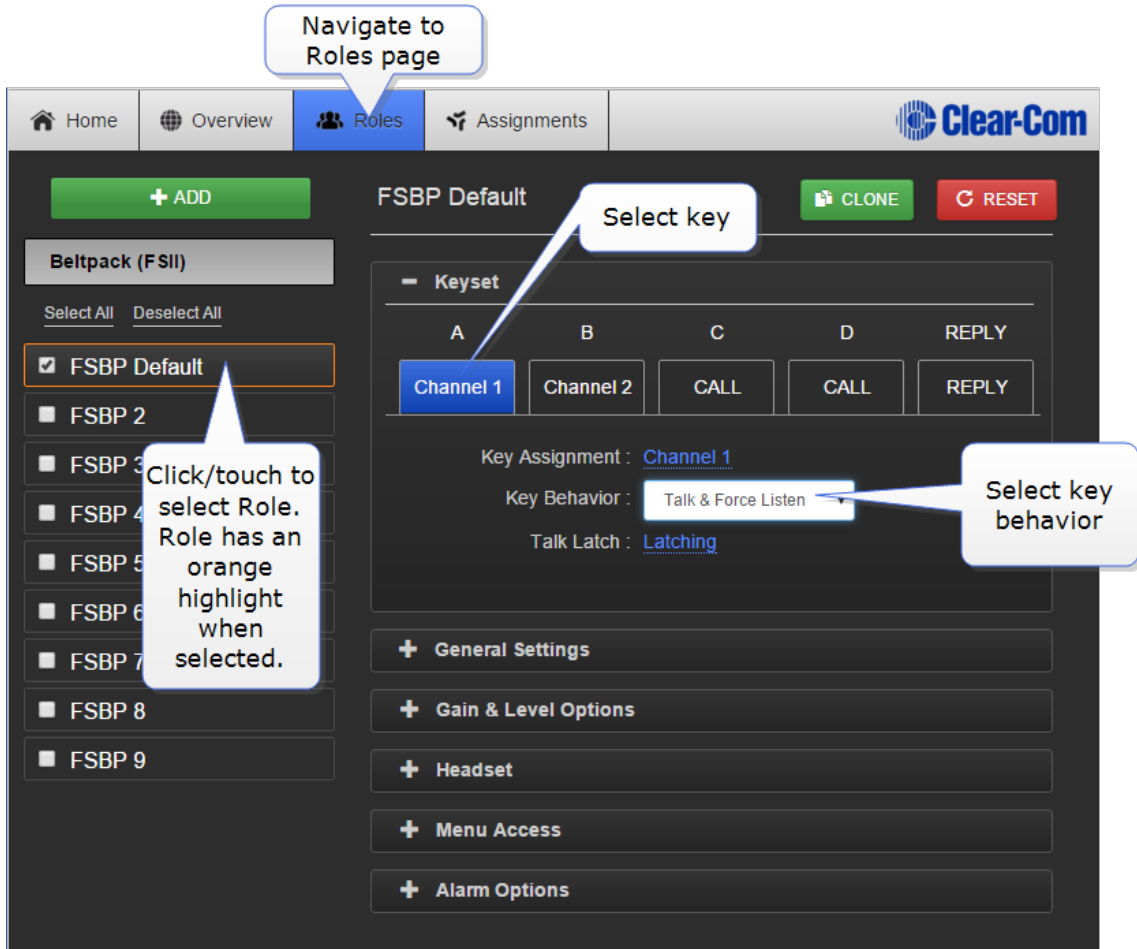

Note: Key behavior is modified by key latch state. When key is set to latch, latch is activated by a quick tap on the key.

6.4 Beltpack default settings

	Key A	Key B	Key C	Key D	Reply
Key Assignment	Channel 1 Channel 1 - 12 Groups 1 - 12 Role 1 - XX (where XX is the number of Roles available) Ports: PRGM, SA, Headset, 2W Partyline 1 - 4 , 4W digital partyline 1 - 4	Channel 2 Channel 1 - 12 Groups 1 - 12 Role 1 - XX (where XX is the number of Roles available) Ports: PRGM, SA, Headset, 2W Partyline 1 - 4 , 4W digital partyline 1 - 4	Call Channel 1 Channel 1 - 12 Groups 1 - 12 Role 1 - XX (where XX is the number of Roles available) Ports: PRGM, SA, Headset, 2W Partyline 1 - 4 , 4W digital partyline 1 - 4	Call Channel 2 Channel 1 - 24 Groups 1 - 12 Role 1 - XX (where XX is the number of Roles available) Ports: PRGM, SA, Headset, 2W Partyline 1 - 4 , 4W digital partyline 1 - 4	Reply Channel 1 - 12 Groups 1 - 12 Role 1 - XX (where XX is the number of Roles available) Ports: PRGM, SA, Headset, 2W Partyline 1 - 4 , 4W digital partyline 1 - 4
Key Behavior	Talk only, Listen only, Talk and Listen, Dual Talk and Listen, Forced Listen, Talk and Forced Listen	Talk only, Listen only, Talk and Listen, Dual Talk and Listen, Forced Listen, Talk and Forced Listen	N/A	N/A	Talk only Listen only, Talk and Listen, Dual Talk and Listen, Forced Listen, Talk and Forced Listen
Talk Latch	Latching/Disabled	Latching/Disabled	Latching/Disabled	Latching/Disabled	Latching/Disabled

General settings

Description	Enter description for Role (optional)
Display brightness	Very low - Very high
Dimmed tallies	Enabled /Disabled
Latch Disabled	Enabled/ Disabled
Reply Auto-Clear	1 - 60 secs (10 sec)
Display Dim timeout	5 - 120 secs (30 sec)
Display Off timeout	5 - 120 secs (30 sec)
Listen Again timeout	Off, 1 -240 mins (240 mins)
Listen Again record	Off, 1 - 15 secs (15 secs)

Gain and level options

Input Gain	15 dB to -70 dB (0 dB)
Output Gain	15 dB to -70 dB (0 dB)
Line-In Volume	6 dB to -15 dB (0 dB)
Master Volume	-0.4 dB to -69.9 dB (0 dB)
Min Master Volume	Off , -24.9 dB, -11.0 dB, - 6.0 dB

Headset

Headset Limit	8 dB to -12 dB (0 dB)
Sidetone Level	0 dB to -24.9 dB (0 dB)
Mic Echo Cancellation	Disabled /Enabled

Menu access

Menu Access Level	Advanced/ Normal /Basic/None
Display Mode	Intercom Mode /Partyline Mode
Master Volume Mode	Talk Keys /Master Volume

Alarm options

Battery Alarm Mode	Vibrate and Audible /Vibrate Only/Audible Only/Off
Low Battery Threshold	0% to 100% (10%)

Call Alert Mode	Vibrate and Audible/Vibrate Only/Audible Only/ Off
Out Of Range Alarm	Audio Only/Off

7 *Beltpack features*

7.1 Menu key operation

The **menu** button on beltpacks has several functions.

- A two second press allows the user to enter menu mode.
- A quick tap on the button can be configured in two different ways by setting 'menu key operation' in **Roles**. This quick tap functionality is called '**Menu Key Operation**'.

Menu Key Operation has two settings:

- Trigger **Listen Again** (replays the last call to the beltpack). **This is the default setting.**
- Switch volume control (A and B, C and D).

Toggle beltpack rotary volume controls between A and B, C and D

This feature allows the user to toggle rotary volume control between keys A and B, and C and D using a quick tap of the menu button. This is helpful if you have different audio sources assigned to each key.

This mode has a 5 second inactive time-out, after which time to rotary controllers will revert to controlling volume on keys A and B. To re-activate this mode in order to adjust C and D, use another quick tap of the menu key. To switch quickly between A and B, and C and D, tap the menu key to toggle.

7.1.1 Set menu key operation

This feature can be set under Roles in the **CCM**, from the Base Station front menus and from the beltpack itself (advanced menu options).

- Set menu key operation in the CCM.

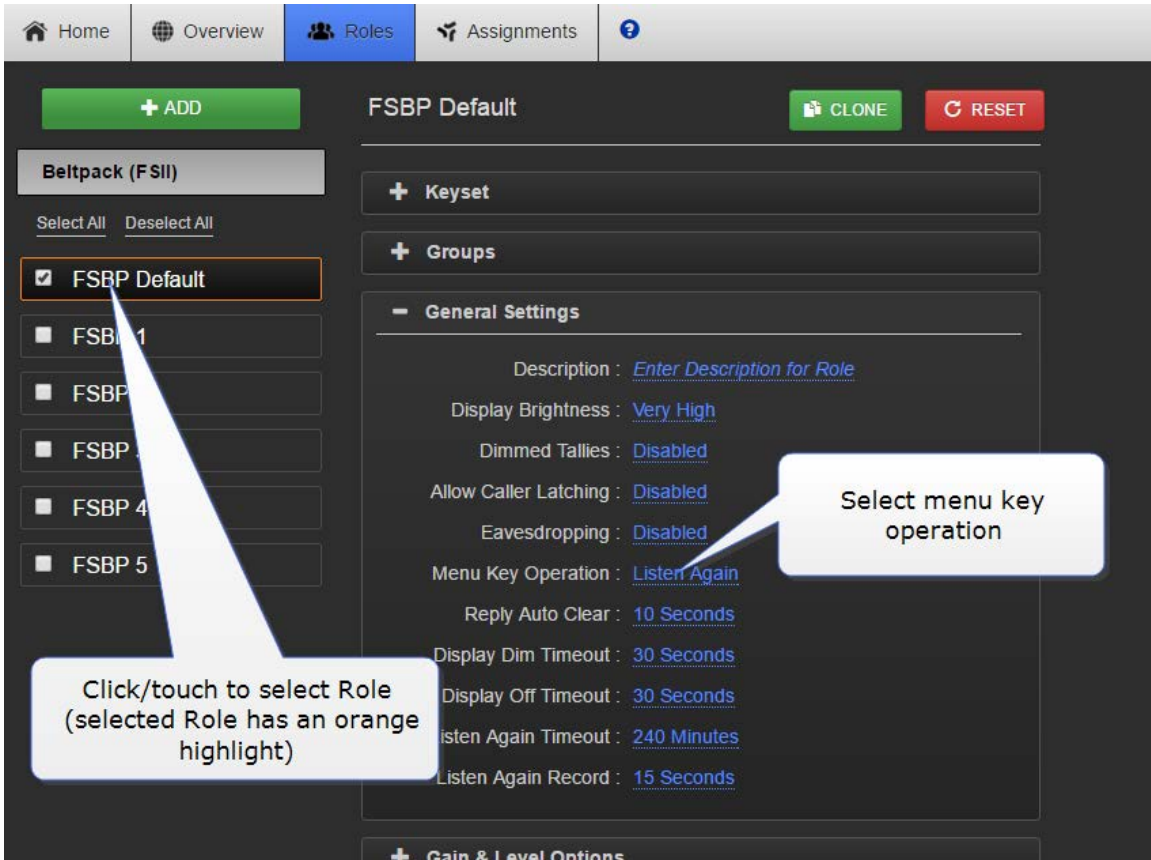

- Set menu key operation from the Base Station menus:

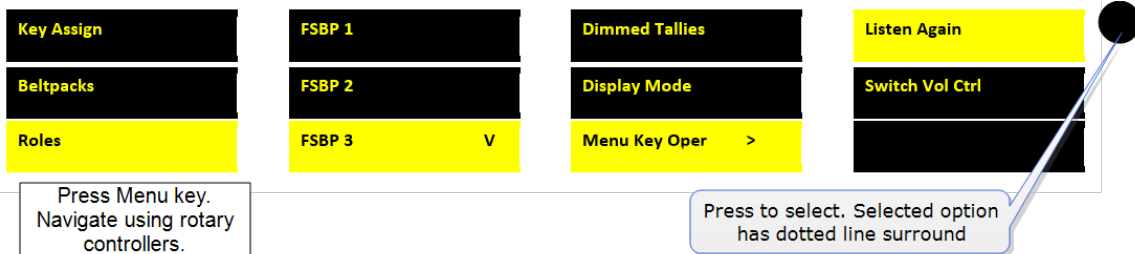

- Set menu key operation from the beltpack: **Menu/Settings/Menu Key Oper**. The beltpack must have advanced menu options enabled (**Roles/Select Role/Menu access**).

7.2 Master volume low level limiter (beltpacks)

7.2.1 About beltpack low level limit

This feature sets a low level limit in order to **prevent** beltpacks from being turned down so low they cannot be heard.

How this feature is used depends on your preferred working practice: it is possible to turn the volume on the beltpack down so low that all audio is inaudible. This can cause confusion among the unwary, although some users may want to turn the volume down completely on occasion.

Values: -6, -12, -21, **-70 OFF**. Default value = **-70 OFF**. If OFF, audio can be turned down so low it cannot be heard at all.

7.2.2 Setting beltpack low level limit

The low level limiter feature is set in **Roles**, from the CCM, The Base Station menus or from the beltpack itself.

- From the CCM

The screenshot displays the CCM interface for configuring roles. The top navigation bar includes Home, Overview, Roles, and Assignments. The main content area is titled 'FSBP Default' and includes a '+ ADD' button, 'CLONE', and 'RESET' buttons. On the left, a list of roles is shown under 'Beltpack (FSII)', with 'FSBP Default' selected and highlighted in orange. A callout box points to this role with the text 'Select beltpack Role (orange highlight on selected Role)'. The main configuration area shows settings for the 'FSBP Default' role, including a keyset table, key assignment, key behavior, talk latch, and headset settings. A callout box points to the 'Headset Low Limit' setting, which is set to 'OFF (-70 dB)', with the text 'Select required level. Default = OFF'.

A	B	C	D	REPLY
Channel 1	Channel 2	CALL	CALL	REPLY

Key Assignment : [Channel 1](#)
Key Behavior : [Talk & Force Listen](#)
Talk Latch : [Latching](#)

+ Groups
+ General Settings
+ Gain & Level Options

- Headset

Headset Limiter : [0 dB](#)
Headset Low Limit : [OFF \(-70 dB\)](#)
Sidetone Level : [-9.6 dB](#)
Mic Echo Cancellation : [Disabled](#)

- From the Base Station menus.

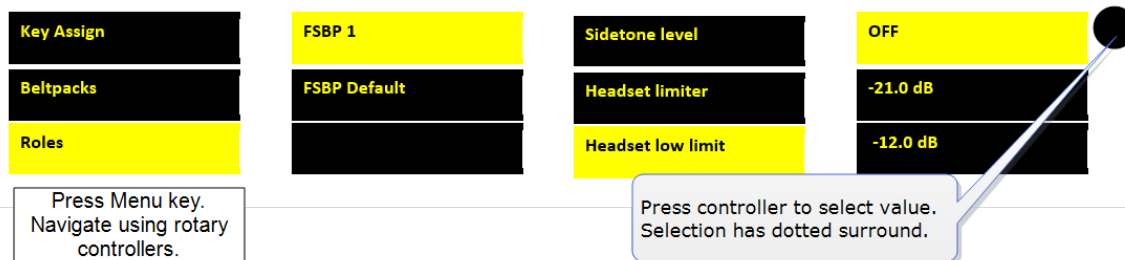

- Set low level limiter on a beltpack: (**Menu/Settings/Headset Options**). The beltpack must have advanced menu options enabled (**Roles/Select Role/Menu access**).

7.3 Configurable eavesdropping

7.3.1 About eavesdropping

Releases of FreeSpeak before FreeSpeak II Base left the beltpack mic permanently open, meaning that audio coming from the beltpack could be listened to even if the user had no active talk routes. This feature can now be configured as required for each beltpack/Role in your wireless system.

The default for FreeSpeak II Base and above is **Eavesdropping disabled**. However, earlier versions will revert to **Eavesdropping enabled**, the headset mic will remain open.

7.3.2 Setting eavesdropping on beltpacks

- Set eavesdropping function in the CCM.

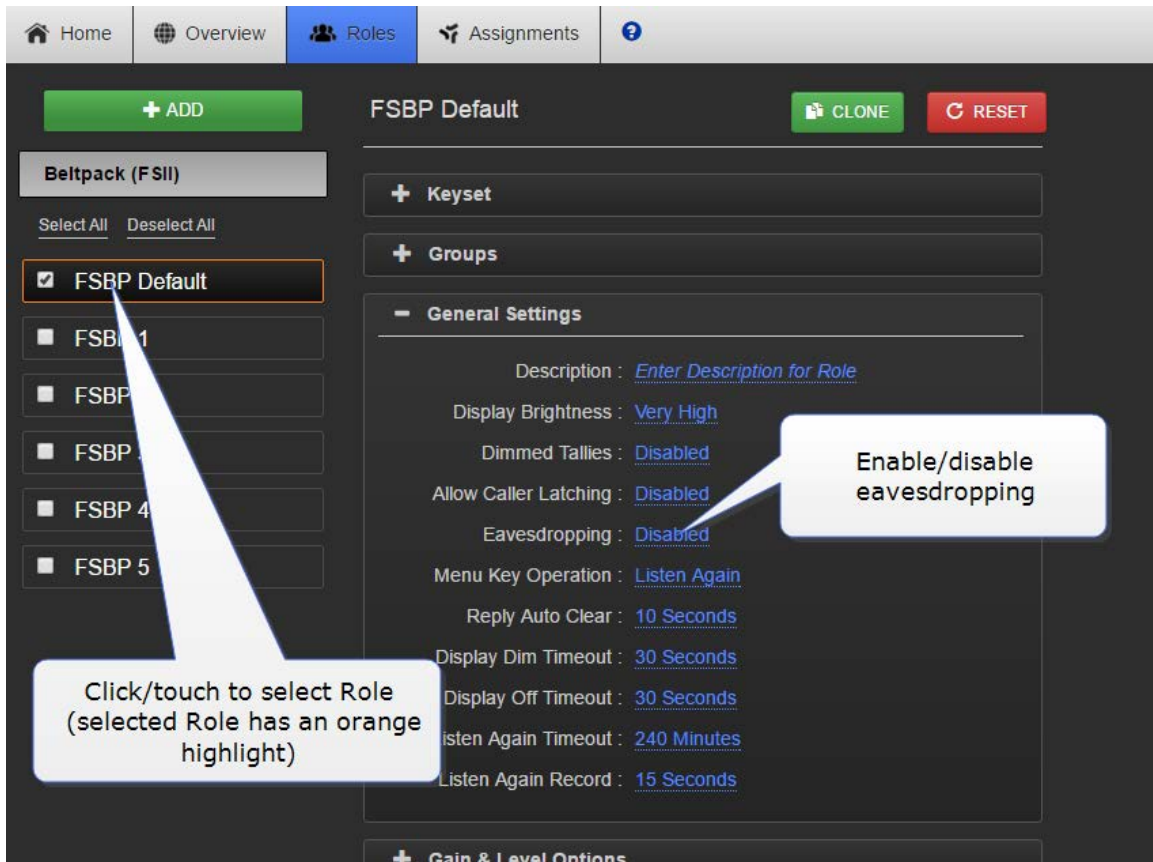

- Set eavesdropping function from the Base Station menus:

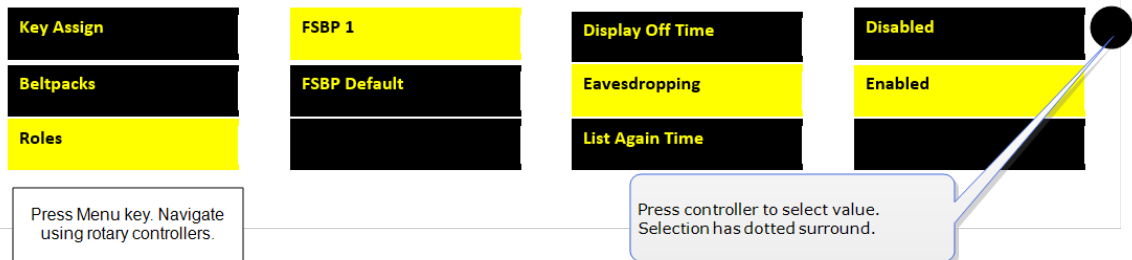

7.4 AA Battery Type: Alkaline/NiMh

7.4.1 About battery type

FreeSpeak II wireless belt packs are supplied with Li-ion batteries and battery charger. However, in some cases you may wish to use AA batteries. Alkaline batteries can be used as a quick, easily available replacement. NiMH batteries can be used in environments (for instance, high atmospheric/hyperbaric) where Li-ion batteries are prohibited.

When using AA batteries of either kind, it is helpful to set battery type so that battery capacity can be monitored accurately. NiMH batteries and alkaline batteries have different discharge patterns and setting this option will allow for that.

Default AA battery type = Alkaline.

7.4.2 Setting AA battery type

- From the Base Station:

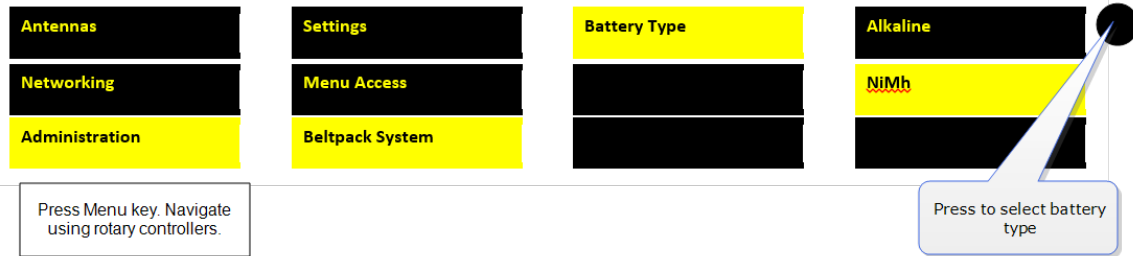

- From the CCM:

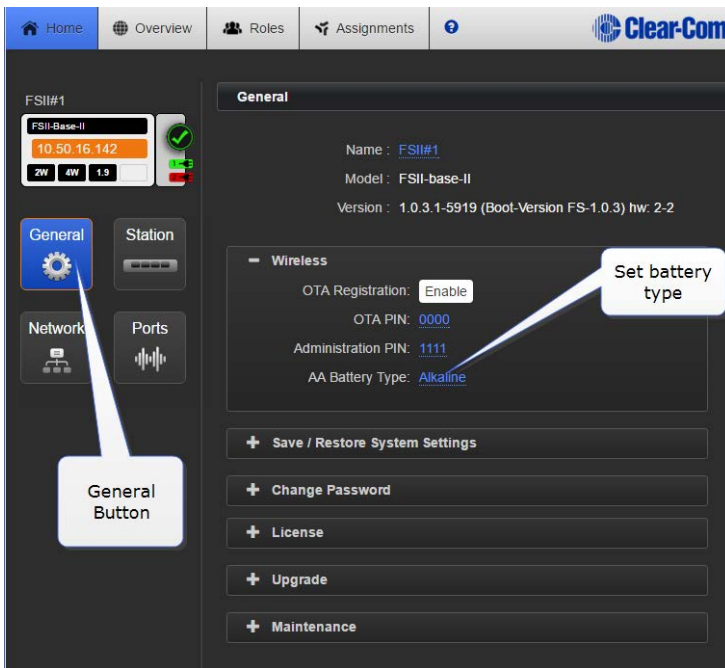

7.5 Using the beltpack functions

7.5.1 Volume operation

Volume operation on beltpacks can be set according to user preference. Control volume operation via the beltpack Role.

Volume operation mode	
Master volume	Rotary controllers adjust volume on all 5 beltpack keys
Talk keys	Left rotary controller adjusts volume on A and B, right rotary controller adjusts volume on C and D.

7.5.2 Controlling volume operation on beltpacks

- From the Base Station:

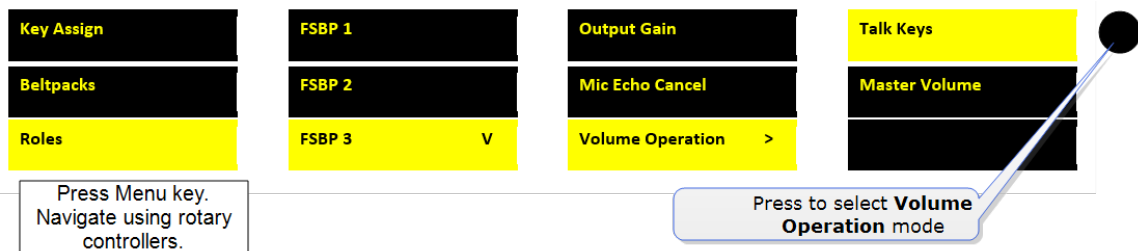

- From the CCM:

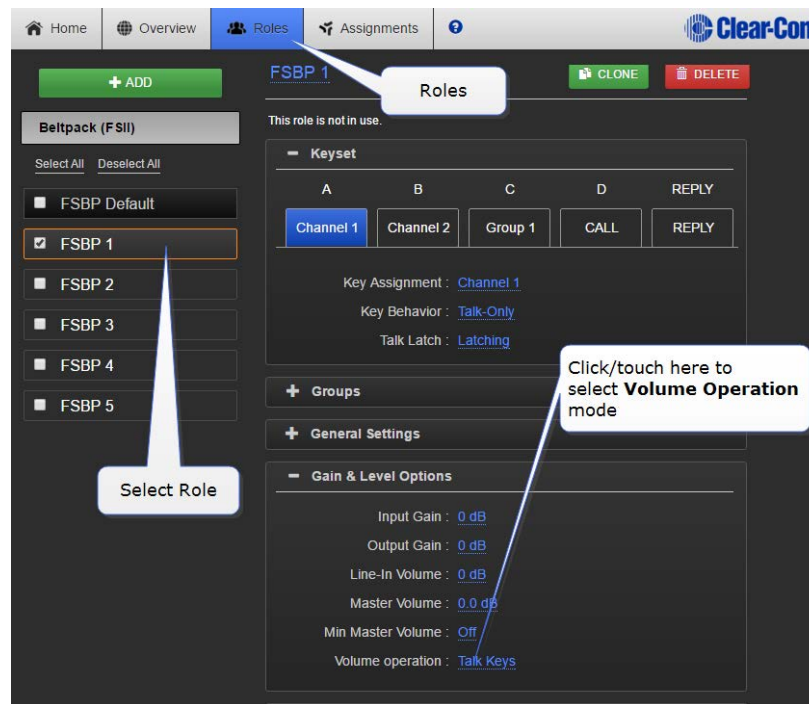

7.5.3 Toggling between volume control on keys A and B, C and D

In addition to the Volume Operation control feature, you can set the beltpack menu button to adjust how the volume controls work.

A quick tap on the menu button can perform two different functions.

Menu key operation (quick tap)	
Menu key operation mode 1 (default)	Trigger Listen Again
Menu key operation mode 2	Toggle rotary control volume adjust between A and B, and C and D. A beep will sound when controllers are switched. Toggle to C and D has a 10 second inactive timeout.

To use this function, navigate to **Menu Key Operation** in Roles.

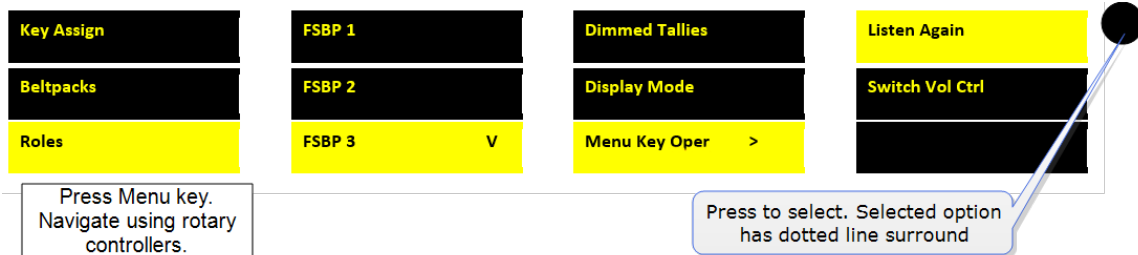

8 Roles

8.1 About FreeSpeak II Base Roles

Use Roles to program beltpack keys with audio and related settings.

A Role is a pre-configured setting, designed to enable rapid system set-up. You will always program audio and related settings for each beltpack via its Role. Your FreeSpeak II Base arrives with default Roles for all your beltpacks (5 or 25 beltpacks according to product and licence).

In FreeSpeak II Base each beltpack has its own Role, and you must have enough Roles before you power beltpacks on. Use the pre-defined Roles, edit the pre-defined Roles, clone existing Roles or create new ones as required.

A Role cannot be used twice in FreeSpeak II Base.

The default Role (which can be edited) uses Channel 1 and 2. Roles also contain settings such as volume, key latching, menu access, Talk and Listen behavior (key behavior) and alerts.

Note: While the purpose of Roles is always to enable fast set-up, how Roles work is influenced by underlying system architecture. This means that they work slightly different across Clear-Com products. Refer to your system documentation for guidance.

8.2 Default Role settings



Your FreeSpeak II Base system arrives with default Roles which can be used 'as is'. The default setting puts all beltpacks and the Base headset into Channel 1 and 2, where they talk and listen in a conference or Partyline set up. Simply register the beltpacks to the Base and select the next available Role when you power the beltpack on.

To use pre-defined Roles, simply select the next available Role for your beltpack when it powers up.

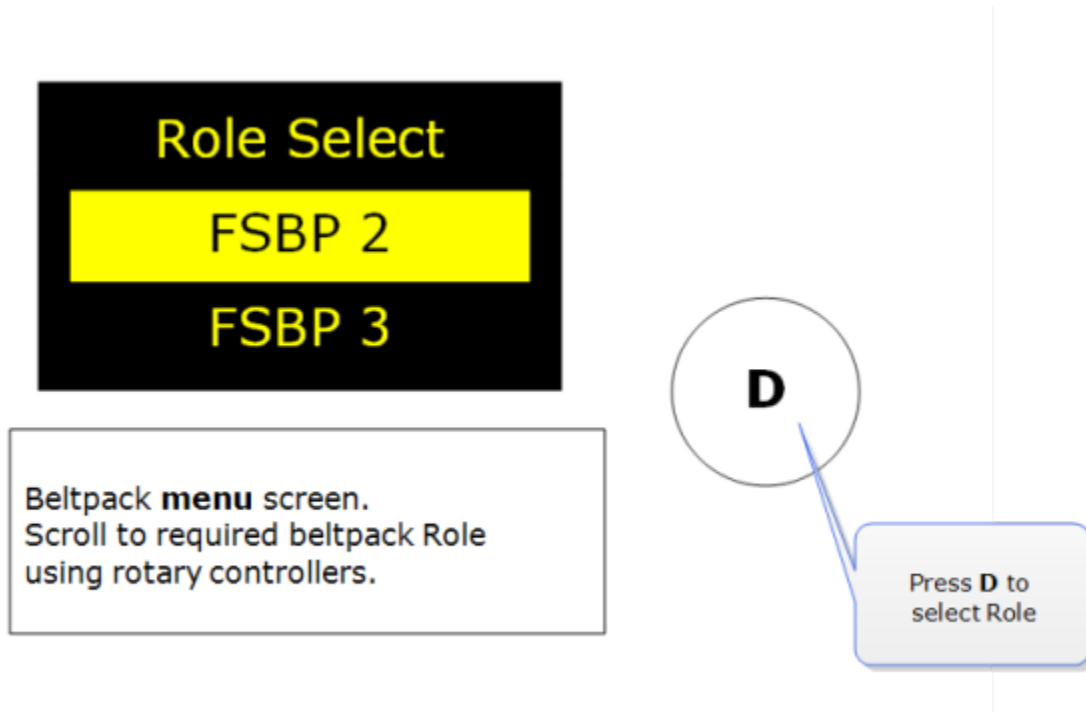

Note: Beltpacks must be registered to the Base before a Role can be selected.

Note: The default Role can be changed to suit your requirements. It can also be reset to factory settings.

8.3 Changing Channels on beltpacks

To change the Channel on a beltpack you will edit the Keyset of that beltpack. This is the same basic process from both the CCM and the Base Station. You will:

- Select the Role (the beltpack configuration map)
- Select the key to change
- Change the audio assignment on the key.

Change channels in the CCM:

Home Overview Roles **Clear-Com**

Navigate to **Roles** page in the CCM

+ ADD **FSBP 2** **CLONE** **DELETE**

Beltpack (FSII)

Select All Deselect All

- FSBP Default
- FSBP 2**
- FSBP 3
- FSBP 4
- FSBP 5
- FSBP 6
- FSBP 7
- FSBP 8
- FSBP 9

Select beltpack Role you wish to edit (selected Role has an orange highlight).

This role is used by 1 .

- Keypad **Select key**

A	B	C	D	REPLY
Channel 1	Channel 2	CALL	CALL	REPLY

Key Assignment : [Channel 1](#) **Click/touch here**

Key Behavior : [Talk & Force Listen](#)

Talk Latch : [Latching](#)

- + General Settings**
- + Gain & Level Options**
- + Headset**
- + Menu Access**
- + Alarm Options**

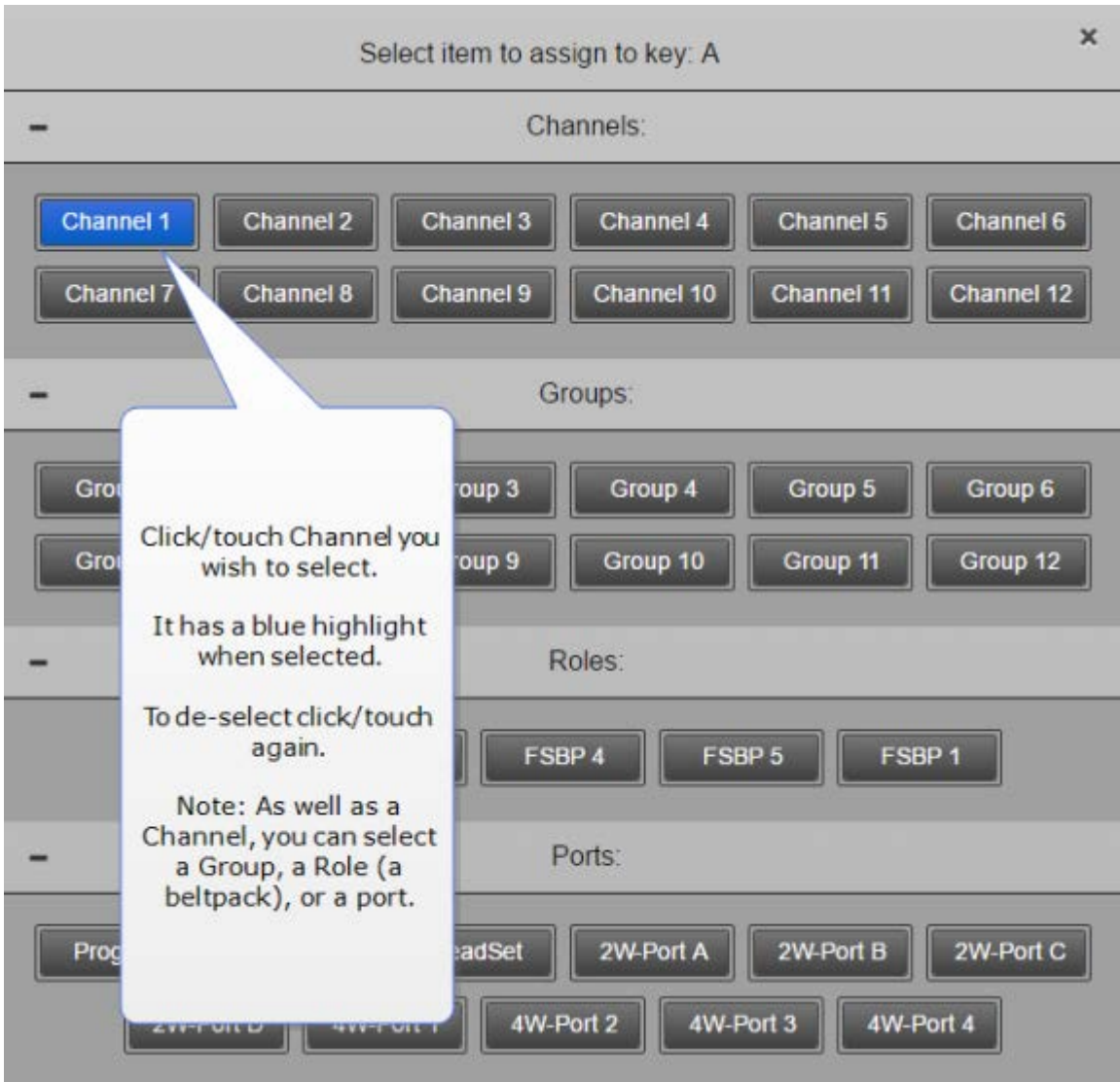

Change channels from the Base Station

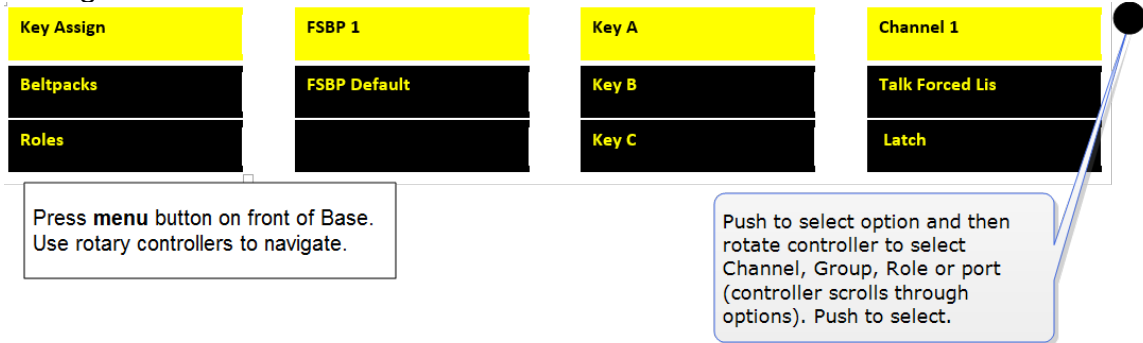

Note: In the CCM you can edit Roles individually or select multiple belt-pack Roles for editing.

8.4 Change beltpack settings

You can change any of the available settings either in the online configuration manager (CCM) or from the Base menu screens (navigate to Roles in the first menu screen). Each page in the CCM has context sensitive help: press ? in the navigation bar.

Note: In the CCM you can edit Roles individually or select multiple beltpack Roles for editing.

Changes you make from the CCM or the Base Station front menu screens are live.

8.5 How to create Roles for beltpacks

You can work with the default Roles, or create new ones. Roles can be deleted.

Create Roles in the CCM.

Navigate to Roles

Home Overview Roles Assignments Clear-Com

+ ADD FSBP Default CLONE RESET

Beltpack (FSII)

Select All Deselect All

FSBP Default

FSBP 1

FSBP 2

Click/touch to select default Role. Selected Role has an orange highlight.

Keyset

A	B	C	D	REPLY
Channel 1	Channel 2	CALL	CALL	REPLY

Key Assignment : Channel 1

Key Behavior : Talk & Force Listen

Talk Latch : Latching

+ General Settings

+ Gain & Level Options

+ Headset

+ Menu Access

+ Alarm Options

Create new Role based on default. Repeat as necessary.

Create Roles from the Base Station menus:

Key Assign

Beltpacks

Roles

FSBP 1

FSBP 2

FSBP 3 V

Label

Delete

Clone v >

Clone Role

Press Menu key. Use rotary controllers to navigate.

Push controller to clone (copy) Role

To use the Roles you create, simply select the Role from your beltpack when it is powered up. You cannot select a Role twice.

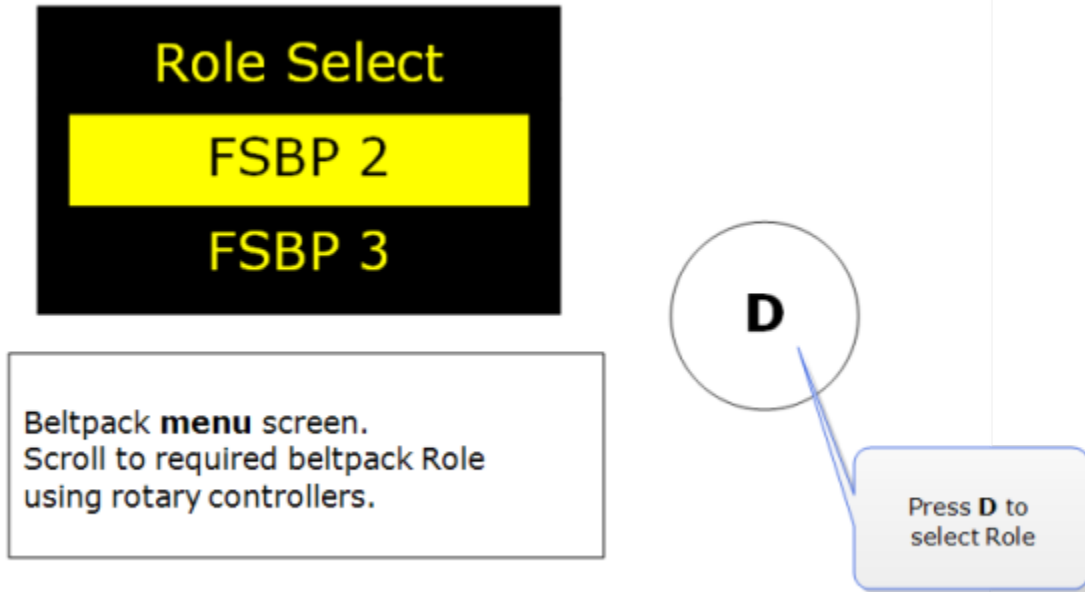

Note: Beltpacks must be registered to the Base before a Role can be selected.

8.6 Save Settings

You can save your Role configuration to a USB or directory. We advise that you do this. Saving settings will save Role, Base Station and antenna configuration.

Save settings from the CCM

Home Overview **Clear-Com**

FSII#1

FSII
10.50.16.33
2W 4W E1

General Network
Station Ports

General

Name : FSII#1
Model : FSII
Version : 0.9.1-5093 (Boot-Version FS-1.0.3) hw: 2-2

+ Wireless

- Save / Restore System Settings

Save Restore

+ Change Password
+ Upgrade
+ Maintenance

backup-04-02-....cca Show all downloads...

Navigate to Home/General

Click/touch '+'

Save

A backup file (.cca) is placed in your download directory. Save this file to a convenient and safe location. This file contains config. for Base Station, beltbacks and antennas.

Save settings from the Base Station menus 1.



Insert USB stick here

2.



8.7 Fixed Roles

A fixed Role, as the name suggests, fixes a Role to a beltpack. This means that the beltpack user does not have to select a Role when they power up the device, as a Role is selected automatically.

For a beltpack to have a fixed Role, it must be already registered to the base. The Role is fixed to the beltpack, either from the CCM or the Base menu screens.

Fix a Role in the CCM:

Home Overview Roles Assignments Clear-Com

Wireless Beltpacks

Antenna Configuration (ip)

ID	Role	Status	1 (ip) ANT1	2 (ip) ANT2	3 (ip) ANT3	4 (ip) ANT4	5 (ip) ANT5	6 (ip) ANT6	7 (ip) ANT7	8 (ip) ANT8	9 (ip) ANT9	10 (ip) ANT10
323594	FSBP 2	1h [Signal]	⊙									
000289	FSBP 3	9h [Signal]			⊙							
262148	FSBP 4	7h [Signal]	⊙									
000776	FSBP 5	7h [Signal]						⊙				

Other Registered Beltpacks

ID	Role

Wireless Beltpack FSII-BP-323594 [Close]

Endpoint Name : [FSII-BP-323594](#)

Fixed Role : [Unassigned](#) [Details](#)

Model : FSII-BP

Version : 0.91.50.0

Id : 323594

Frequency Type : 2.4

Status : online

Antenna ID : 1

Antenna Label : ANT1

Battery Type : Li-Ion

Battery Level : 1:20 (7%)

Error rate : 1

RSSI : 52

[+ Maintenance](#)

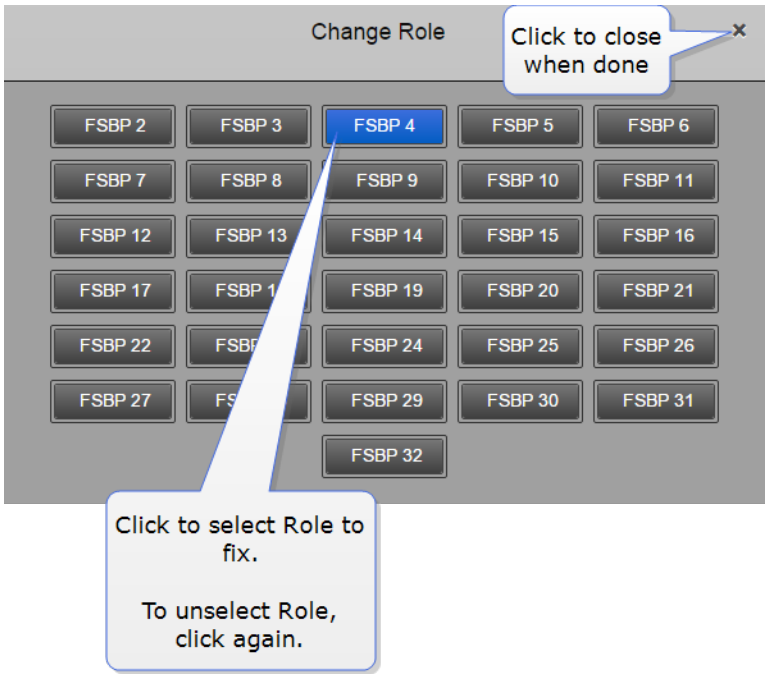

Fix a Role from the Base menu screens:

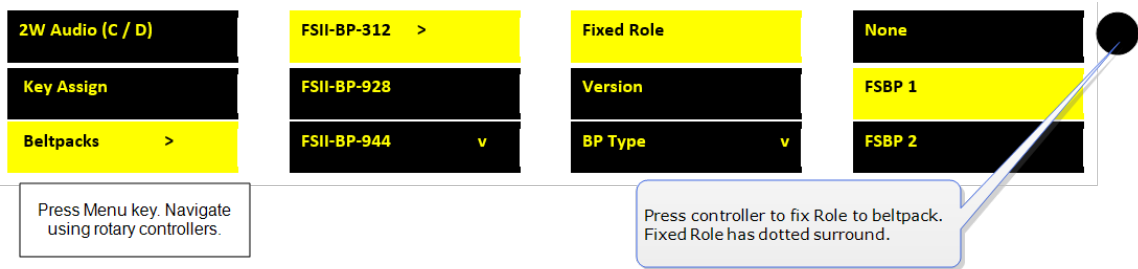

9 Core Configuration Manager (CCM)

The Core Configuration Manager is a quick and convenient way to configure your FreeSpeak II system.

9.1 How to access the CCM

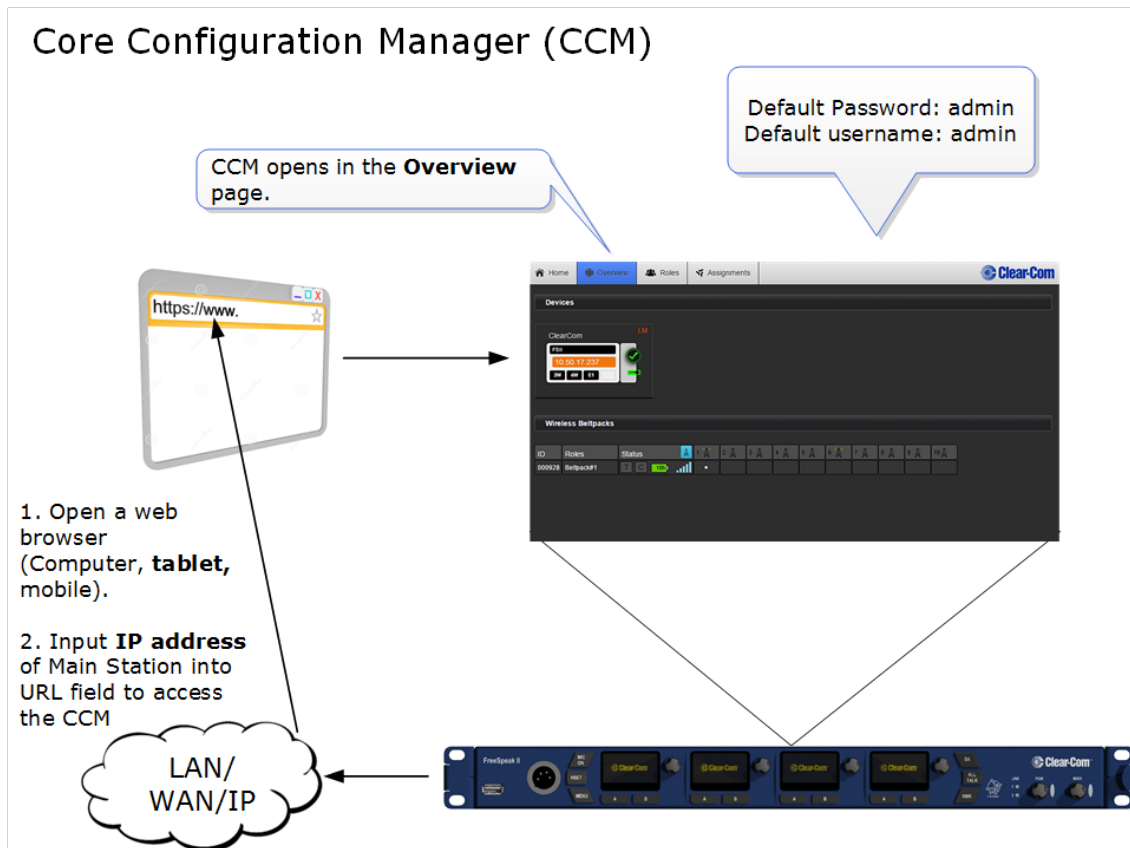

- 1) Make sure the Base Station is connected to a network (either LAN connector on back of device).
- 2) Open a browser (PC, tablet, mobile) and input the IP address of your Base Station in the URL field. Find the IP address in the front menu screens of your device: **Menu/Networking/Preferences/IP address**.

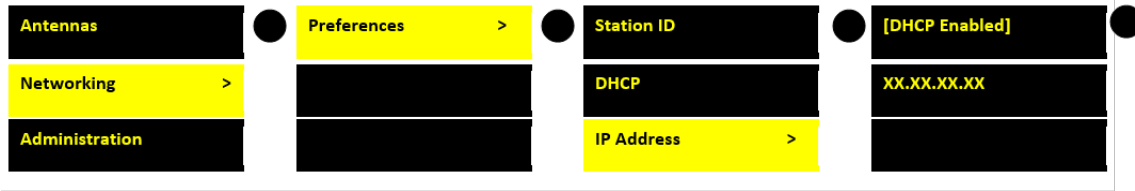

Press **MENU** button on front of Base for menu mode.
Navigate menus using rotary controllers.

The default username is: admin. The default password is: admin.

This takes you to the Overview page of the CCM for your device.

Note: If you cannot access the CCM for your Base you may have an IP conflict. Check with your network administrator. Your device network settings are set to Dynamic Host Control Protocol (DHCP) by default.

9.2 CCM walkthrough

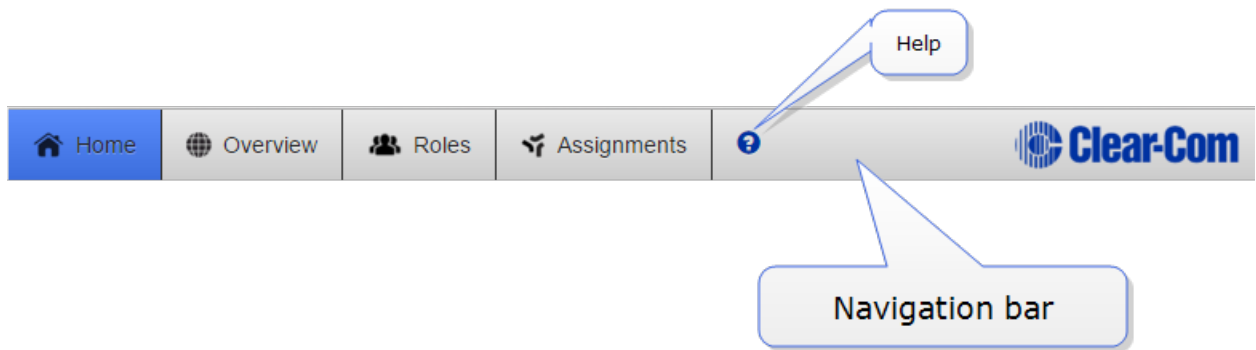

Click or touch the navigation bar to reach pages.

For context sensitive help, click/touch the help button (?).

9.2.1 Overview Page

This screen is the diagnostics screen for your FreeSpeak II Base system. It gives a live overview of antennas and beltpacks in your system.

Click on any device in this page to access information and configuration options. Click on blue text fields to edit.

Antennas 1 - 5: antenna port 1 on Base Station
Antennas 6 - 10: antenna port 2 on Base Station

2.4 GHz frequency range: blue
1.9 GHz frequency range: green

See **Cable Compensation** for more information.

Click to see details for FSBP1

Click to see details for antenna 1

Beltpack powered off

Overall signal strength

Battery life

Beltpack has been registered with Base but is currently not in use

ID	Role	Status	1 (ANT1)	2 (ANT2)	3 (ANT3)	4 (ANT4)	5 (ANT5)	6 (ANT6)	7 (ANT7)	8 (ANT8)	9 (ANT9)	10 (ANT10)
323594	FSBP 1											
000288	FSBP 2											
000586	FSBP 3											
000776	FSBP 4											

Other Registered Beltpacks	
ID	Role
262148	FSBP 8

Note: All system changes are live.

- Antennas 1 - 5: antenna port 1 on Base Station
- Antennas 6 - 10: antenna port 2 on Base Station

9.2.2 Home page

The Home page is where you find configuration options specific to your Base Station. Go ahead and explore the pages!

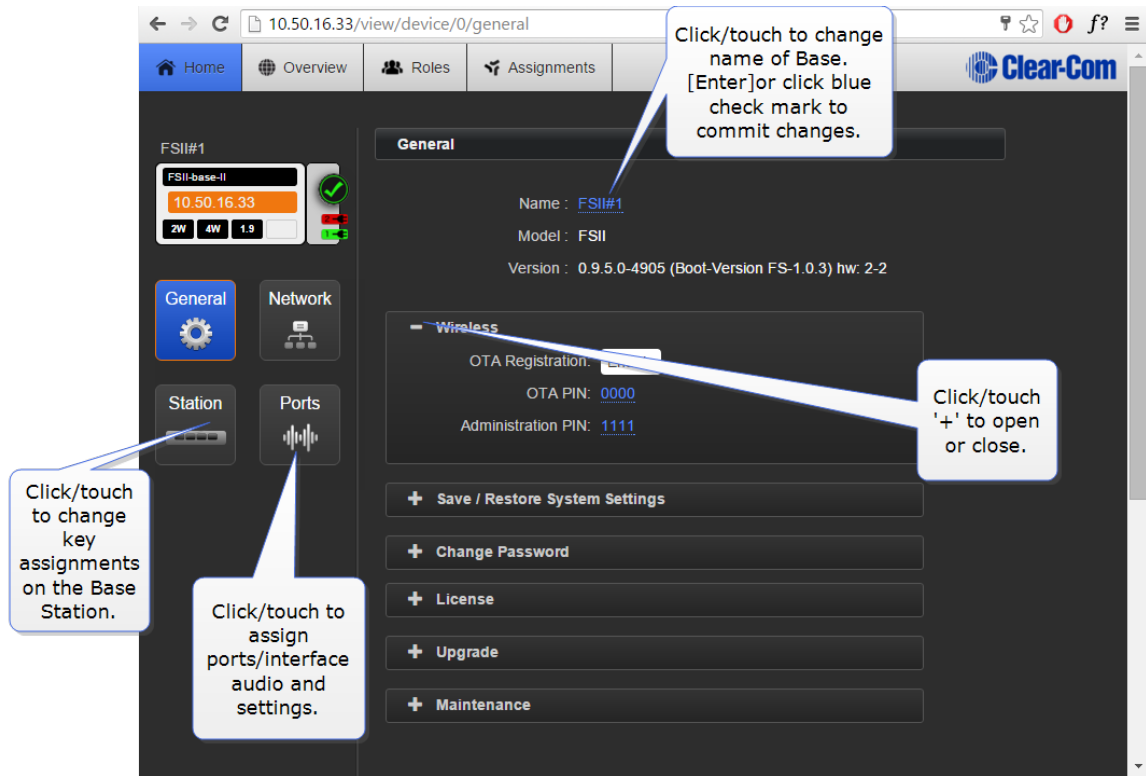

9.2.3 Roles Page

The Roles page is where you assign audio to beltpacks and configure beltpack settings.

Roles are pre-configurations; default audio routes and settings that are applied to your device when it is first powered up (a Role is selected by the beltpack user). The default Role can be edited and/or reset to default. Individual Roles can be edited, deleted, cloned and created.

In FreeSpeak II Base a Role is attached to a specific beltpack in a one-to-one relationship. The default Role puts Channel 1 and 2 on beltpack keys A and B, with C and D set as call keys. The Reply key can be re-assigned to a Channel as required.

Below is the Beltpack default configuration.

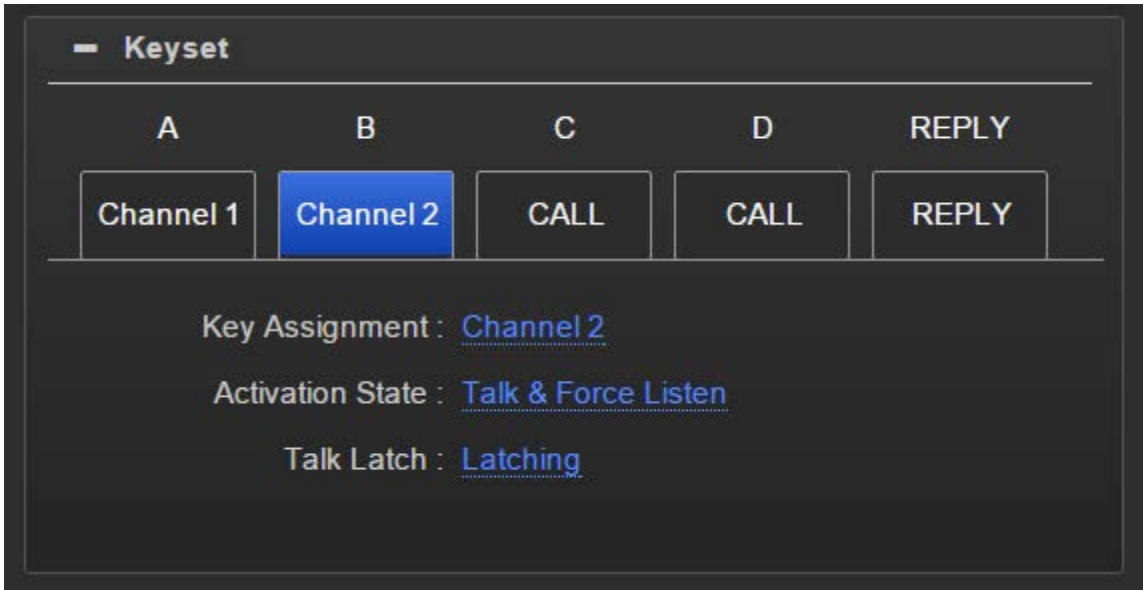

On the Roles page you can edit, create, clone and delete Roles.

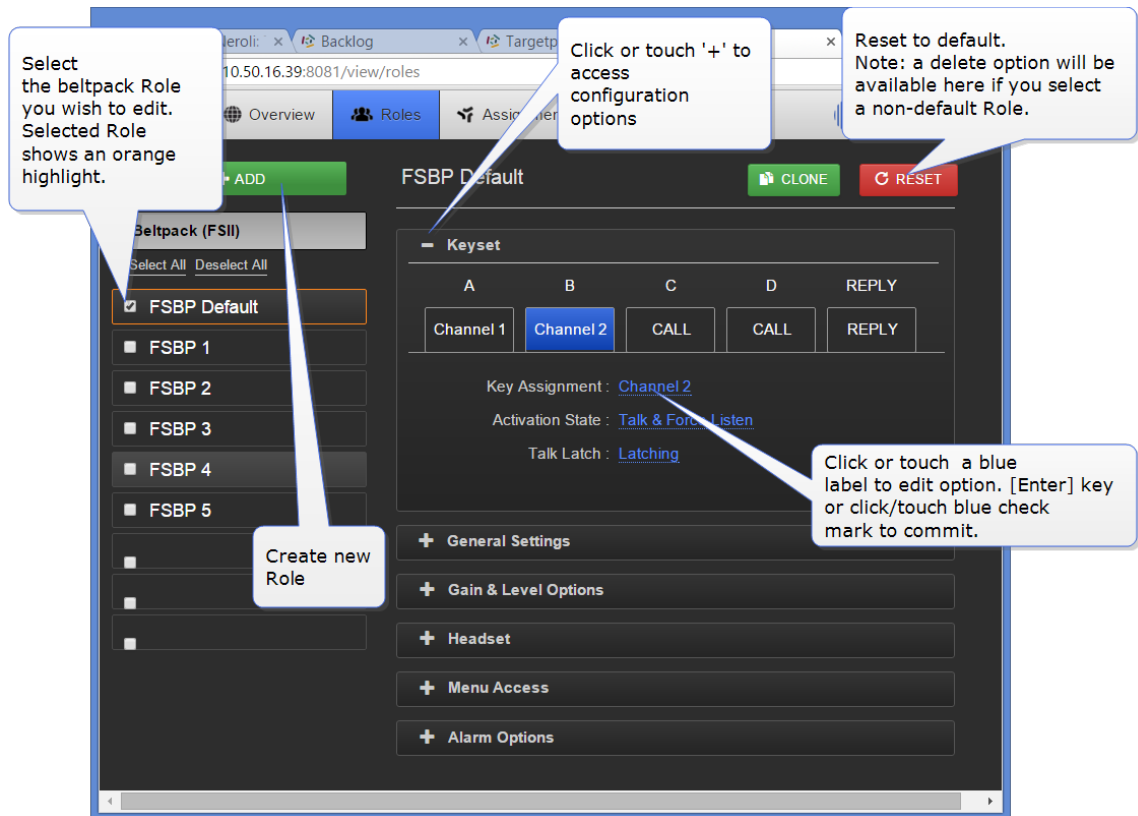

All Roles can be edited as required.

You can save your Roles to a USB stick or directory for convenience (advised).

How to save Role settings

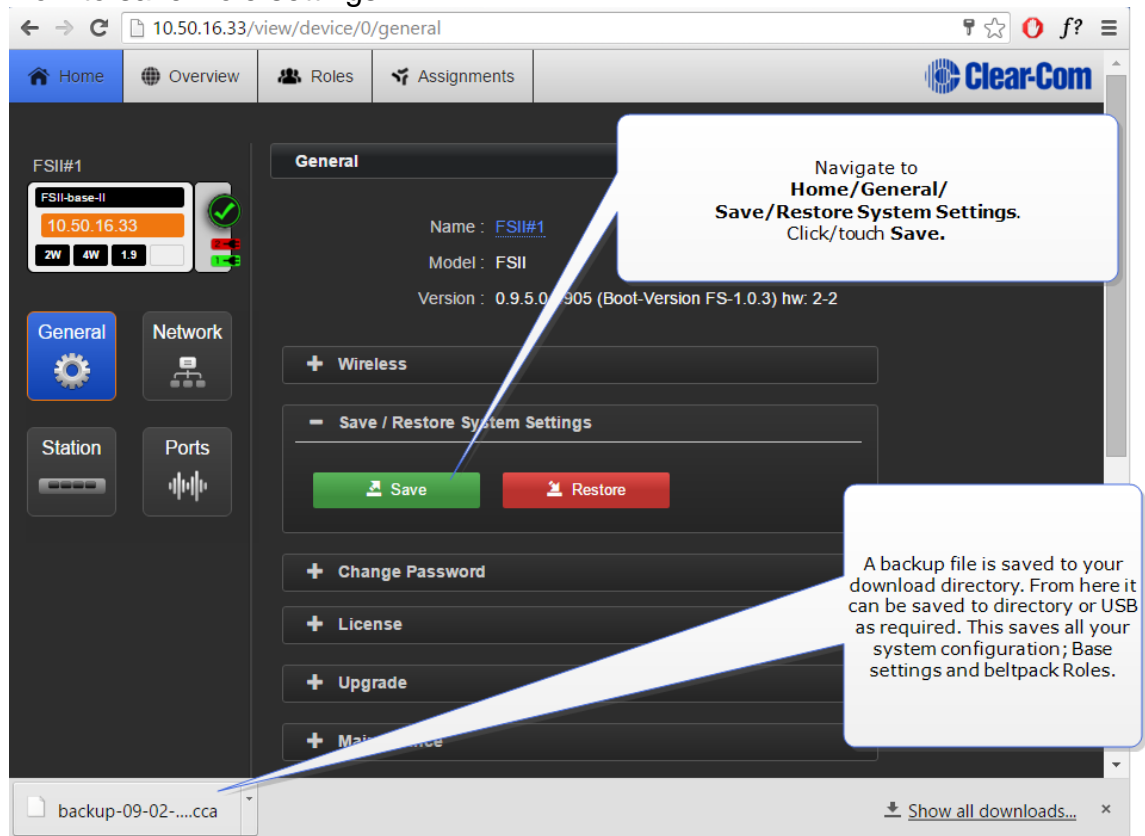

9.2.4 Assignments Page

On this page you see audio assignment in Channels. This screen is a live representation of anyone talking or listening in up to 24 Channels. You can toggle between 'Roles' view and 'Hostname' view. Hostname view can be used to show individual beltpack hardware.

The screenshot shows the Clear-Com web interface for channel management. The browser address bar displays '10.50.17.237/view/connections'. The navigation menu includes 'Home', 'Overview', 'Roles', and 'Assignments'. The 'Assignments' tab is active, showing a 'Channels' icon and two radio buttons for 'Roles' and 'Hostnames'. Below this, six channel configuration panels are visible. Channel 1 is configured with '2W-Port A', '4W-Port 1', 'Program', 'FSBP 3', and 'FSBP 2'. Channel 2 has 'HeadSet', 'FSBP 3', and 'FSBP 2'. Channel 3 has 'HeadSet'. Channels 4, 5, and 6 are currently empty. Callout boxes provide instructions: one points to the 'Channels' icon, another to the blue channel labels, and a third to the arrows on the channel 1 configuration.

Click or touch to toggle between Roles view and Hostnames

Channel names can be changed in this page. Click or touch a blue label. [Enter] key or blue check mark to commit.

Arrows indicate active Talk and Listen paths

10 Configuring audio routes

10.1 About audio routes

10.1.1 Channels

In FreeSpeak II Base, audio routes can be made between beltacks and external interfaces by putting all members (audio feeds and beltacks) in a Channel together. In this way, beltacks, audio and the controller all communicate with each other. A Channel operates as a Partyline or conference.

You can see all sources in a Channel in the Assignments page.

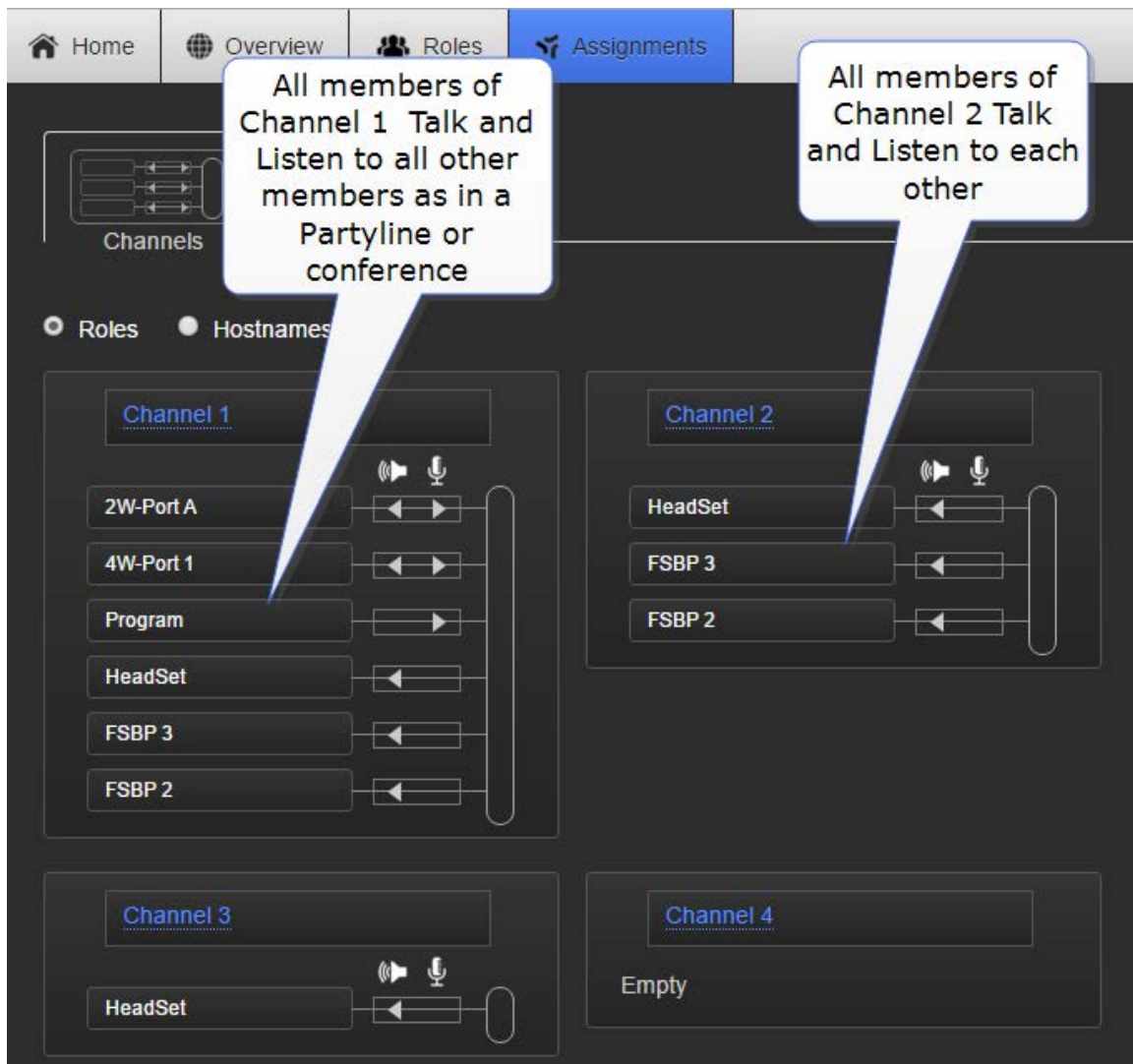

Note: Channels are set to 'Talk and Forced Listen' by default. See **6.3.1 Key behavior** for more information.

10.1.2 Groups

Audio can also be configured into Groups. Groups are programmed in a similar way to Channels; simply assign the audio sources to the Group (Group Members) and then program a key to talk to the Group. Ports, the Base headset, and belt packs can all become Group members. Once a Group member, you can hear announcements to the Group, and reply using the Reply key.

Note: You can see all members of a Group at a glance in the Assignments page of the CCM. Navigate to Assignments and click/touch the Group tab. Belt packs will not be visible in the Group until they are online.

10.1.3 Channels or Groups?

Both Channels and Groups are essentially digital containers for digital audio sources, allowing communication between members.

Channel

A Channel operates as an intercom Partyline or conference. All members can talk to and listen to all other members, as long as they have keys to do so.

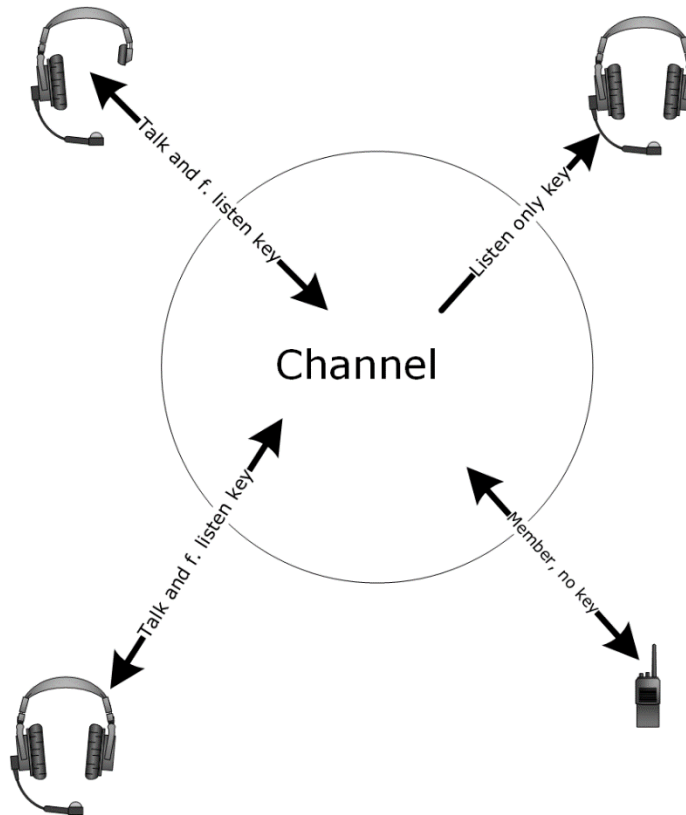

To put a beltpack into a Channel:

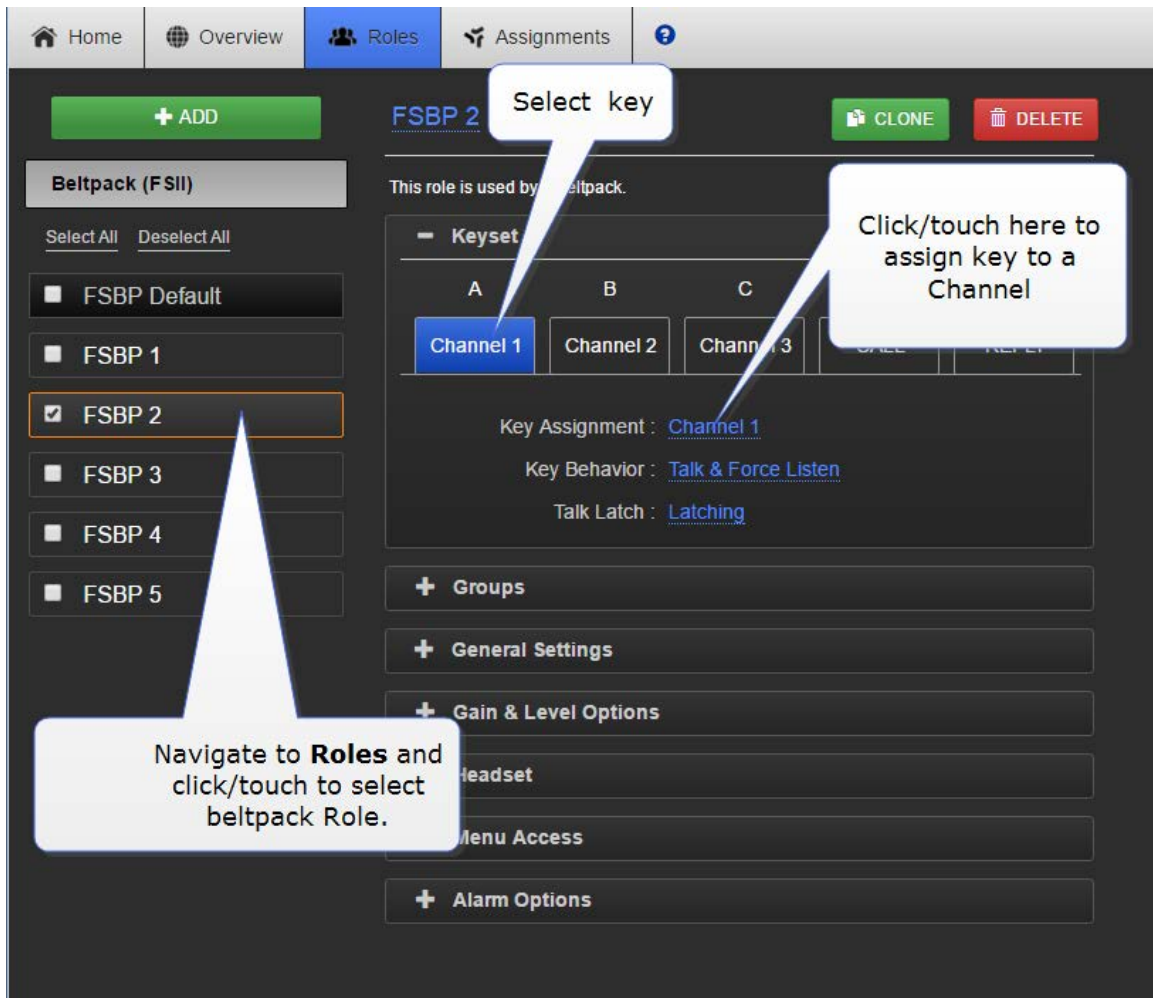

Note: The default key behavior setting for a member of a Channel is 'Talk and Forced Listen'. See **6.3.1 Key behavior** for more information.

Note: You can see Channel members in the Assignments page of the CCM. Navigate to Assignments.

Group

A Group configuration enables an announcement or broadcast to a number of members simultaneously.

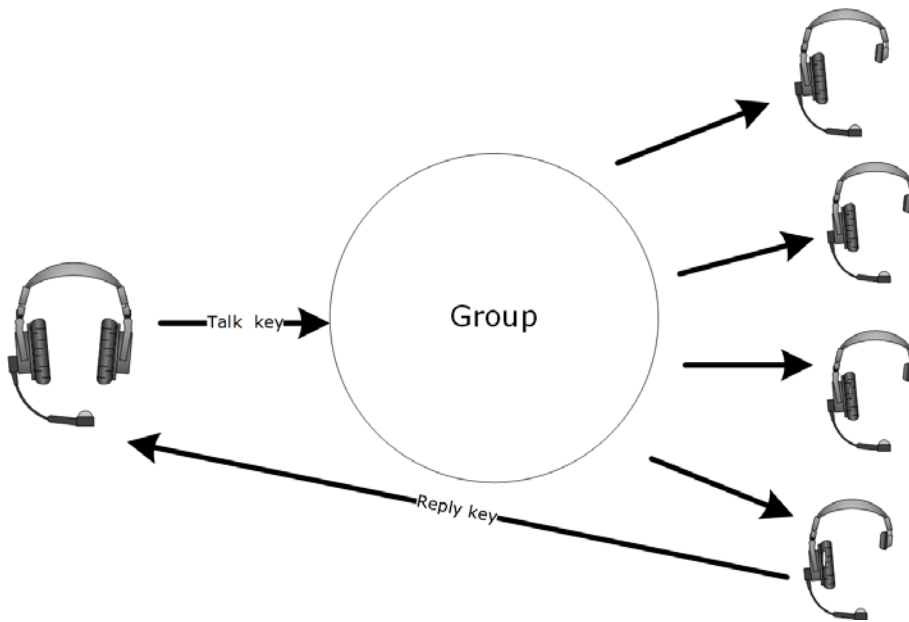

A group member can reply directly to the announcer using the Reply key. The other group members will not hear this.

Example Group set up

To set up a Group you must first put the members in the Group. Ports, Beltpacks and the Base headset can all become members of a Group. When the members of the Group are assigned, you must program a key to talk to the Group members.

To assign a port to group membership from the CCM:

The screenshot displays the 'Ports' configuration page in the Clear-Com web interface. At the top, there is a navigation bar with 'Home', 'Overview', 'Roles', and 'Assignments'. The user profile 'Mary Enna' is shown on the left, along with device information: 'FSII-Base-II', IP '10.50.16.142', and '2W 4W 1.9'. A sidebar on the left contains 'General', 'Station', 'Network', and 'Ports' (highlighted with a callout: 'Navigate to Home/Ports').

The main content area is titled 'Local ports' and features a warning: 'Changes will be applied to all selected Ports'. It is divided into three sections:

- 2-Wire:** A list of ports A, B, C, and D. '2W-Port A' is selected (checked), while B, C, and D are not.
- 4-Wire:** A list of ports 1, 2, 3, and 4. '4W-Port 1' is selected (checked), while 2, 3, and 4 are not. A callout points to this section: 'Select port(s). Multiple ports can be selected.'
- Station:** Options for 'PGM Program' and 'SA SA'.

 To the right, a 'Port Settings' panel is visible, showing:

- Label: [Multiple Values]
- Channel Assignment: Unassigned
- Group Membership: Group 1 (with a callout: 'Click/touch to make ports Group members.')
 - Input Gain: 0 dB
 - Output Gain: 0 dB
 - RX Call Signal: Disabled

How to program a Talk key to the Group.

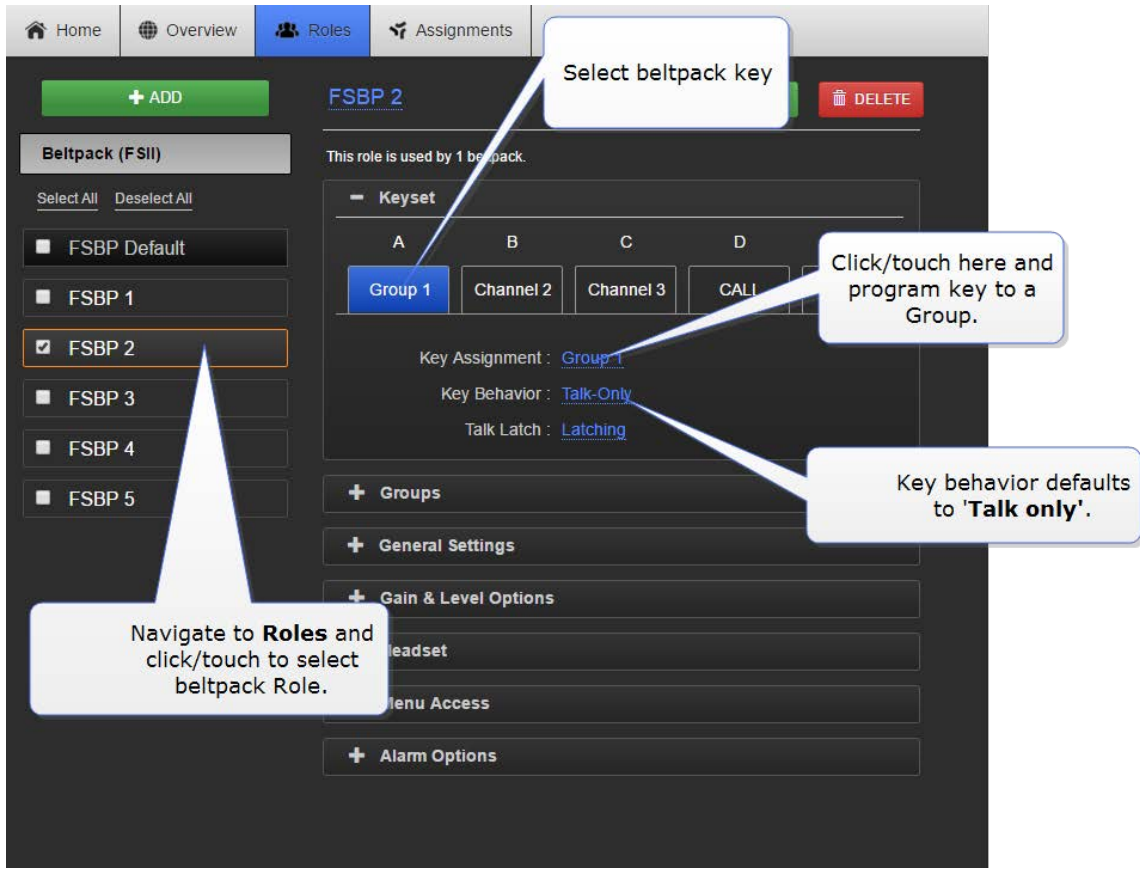

Note: The default key behavior setting for a talk key to a Group is 'Talk Only'. See **6.3.1 Key behavior** for more information.

You can see Group members in the Assignments page of the CCM. Navigate to Assignments and click/touch the Groups tab. Beltpacks will only be visible in the Group when they are online.

10.2 Example audio assignment

Follow steps 1. to 3. to connect audio from external devices to the Base Station, populate Channels and set up communication with beltpacks.

- 1) Connect 2-Wire or 4-Wire audio devices to interfaces/ports.

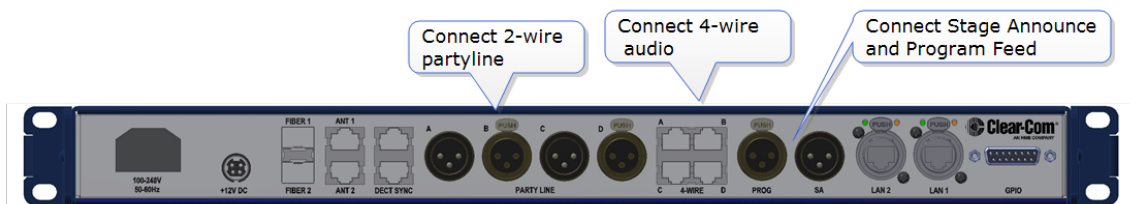

2) Assign interfaces/ports to Channels.

Setting audio on interfaces/ports can be done from the CCM:

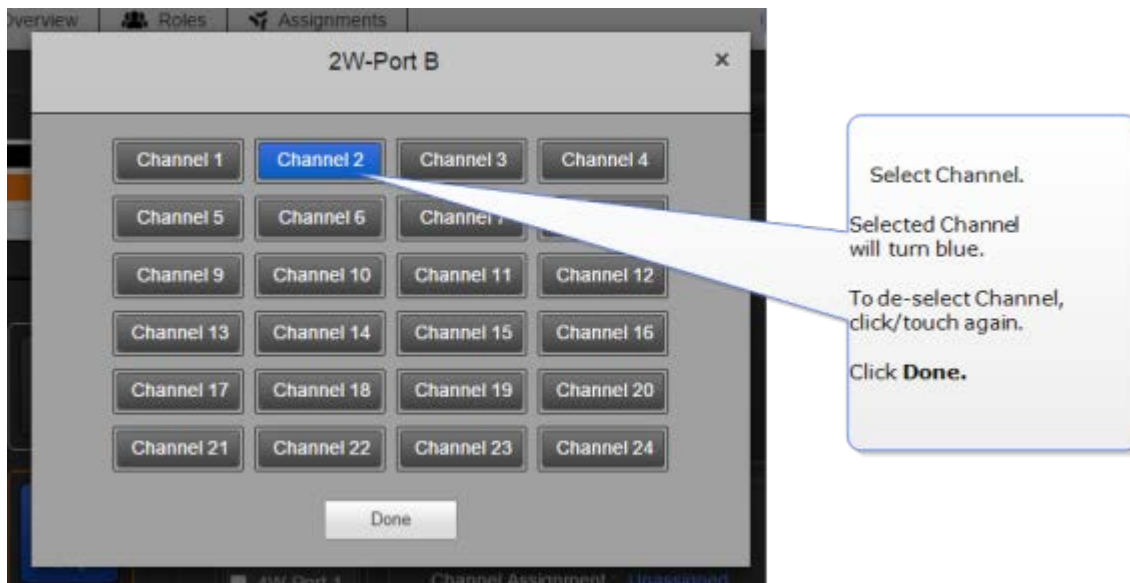
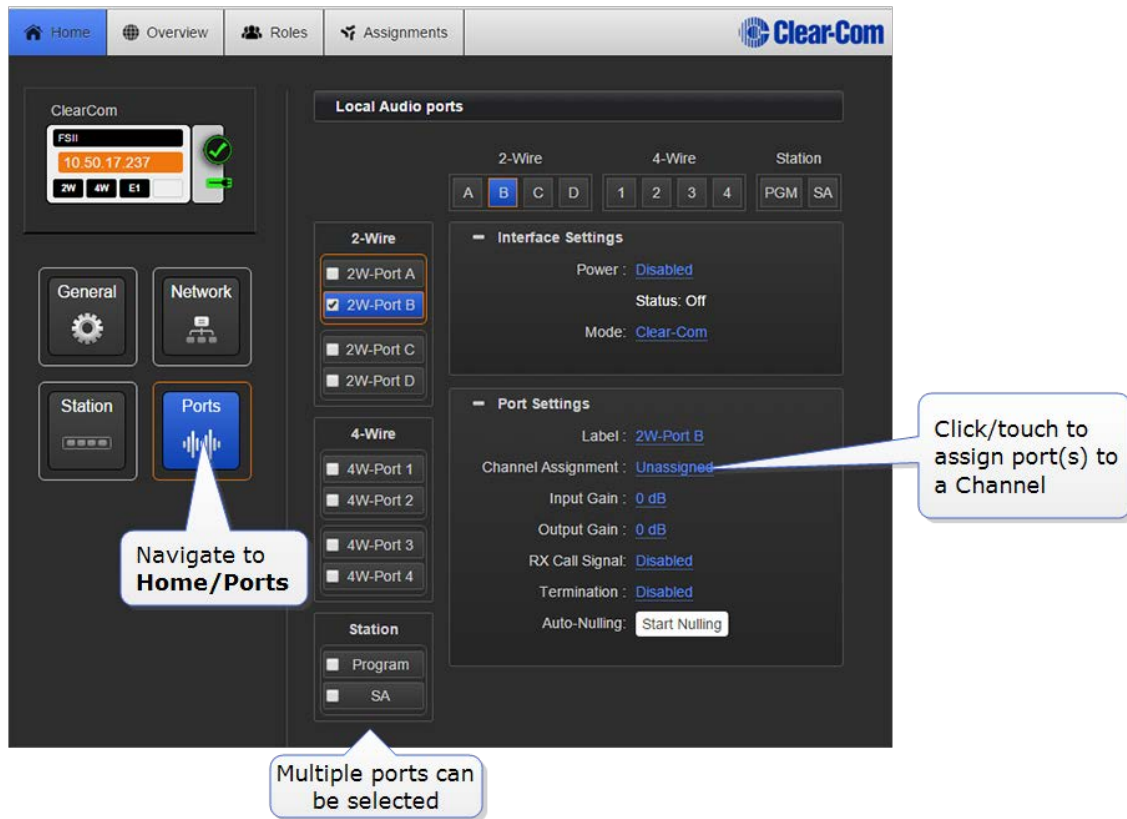

Setting audio on interfaces/ports can be done from the Base Station:

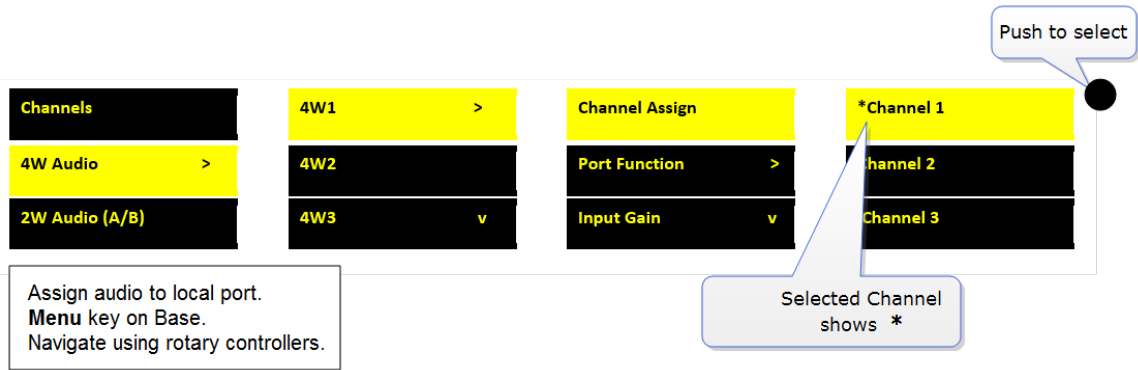

Note: Configure port settings (power, termination, port function, port levels etc.) as required.

3) Assign Channels to beltpack keys (A, B, C, D, Reply)

Audio assignment for beltpacks is always done with a Role. A Role is a pre-defined beltpack configuration map. You select a Role for a beltpack when it is first powered on. The Role a beltpack is using can be changed from the Base station, the CCM or the beltpack itself.

In the first case, it is easiest to use the default Role. This puts Channel 1 and Channel 2 on to the beltpack keys.

To change the Channel on a beltpack you need to edit the Role that beltpack is using. Find the beltpack Role name at the bottom of the beltpack screen:

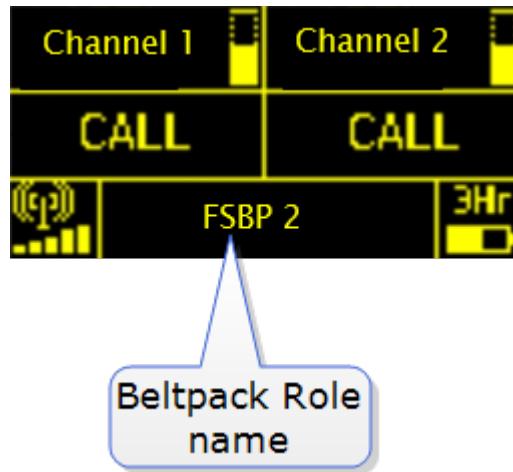

Edit Belt pack Roles in the CCM:

Home Overview Roles **Clear-Com**

Navigate to **Roles** page in the CCM

+ ADD **FSBP 2** **CLONE** **DELETE**

Beltpack (FSII)

Select All Deselect All

- FSBP Default
- FSBP 2**
- FSBP 3
- FSBP 4
- FSBP 5
- FSBP 6
- FSBP 7
- FSBP 8
- FSBP 9

Select beltpack Role you wish to edit (selected Role has an orange highlight).

This role is used by 1 .

- Keypad **Select key**

A	B	C	D	REPLY
Channel 1	Channel 2	CALL	CALL	REPLY

Key Assignment : [Channel 1](#) **Click/touch here**

Key Behavior : [Talk & Force Listen](#)

Talk Latch : [Latching](#)

- + General Settings**
- + Gain & Level Options**
- + Headset**
- + Menu Access**
- + Alarm Options**

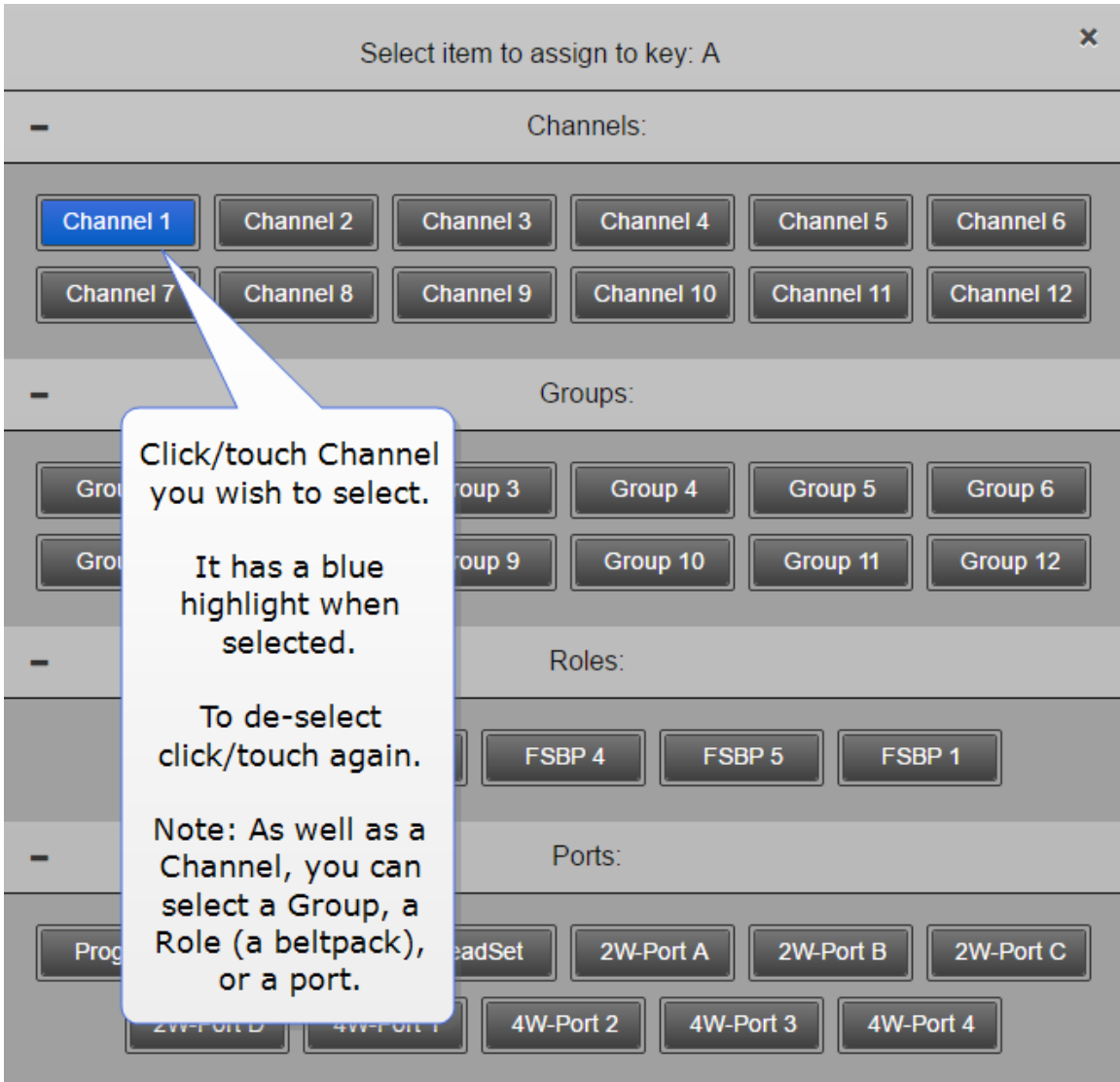

Edit Beltpack Roles from the Base Station:

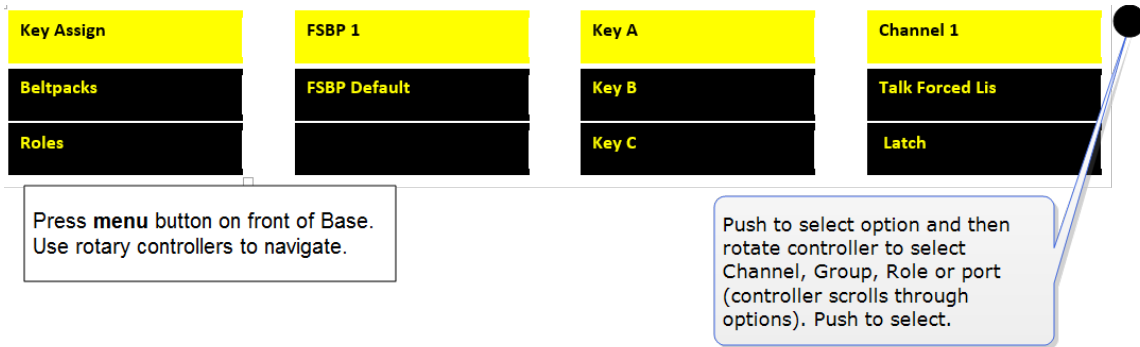

Note: You can assign audio to keys C, D and Reply. To return the status of these keys to Call and Reply, you must deselect or unassign the audio assignment. A selected assignment turns blue in the CCM. Click on a blue assignment again to deselect it. From the Base Station menu screens go to **Key Assign/Role/Key/Unassigned**.

10.3 Change key assignments on the Base Station

10.3.1 Change Channel settings on the Base Station.

The Base Station default setting has Channels 1 - 3 on the first three Keysets. The 4th Keyset is a Reply key.

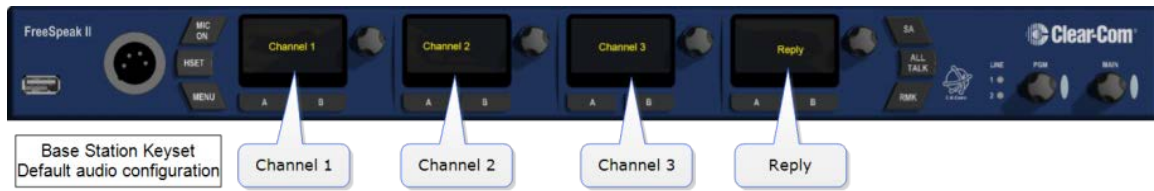

This can be edited.

Change Base Station key assignment from the CCM:

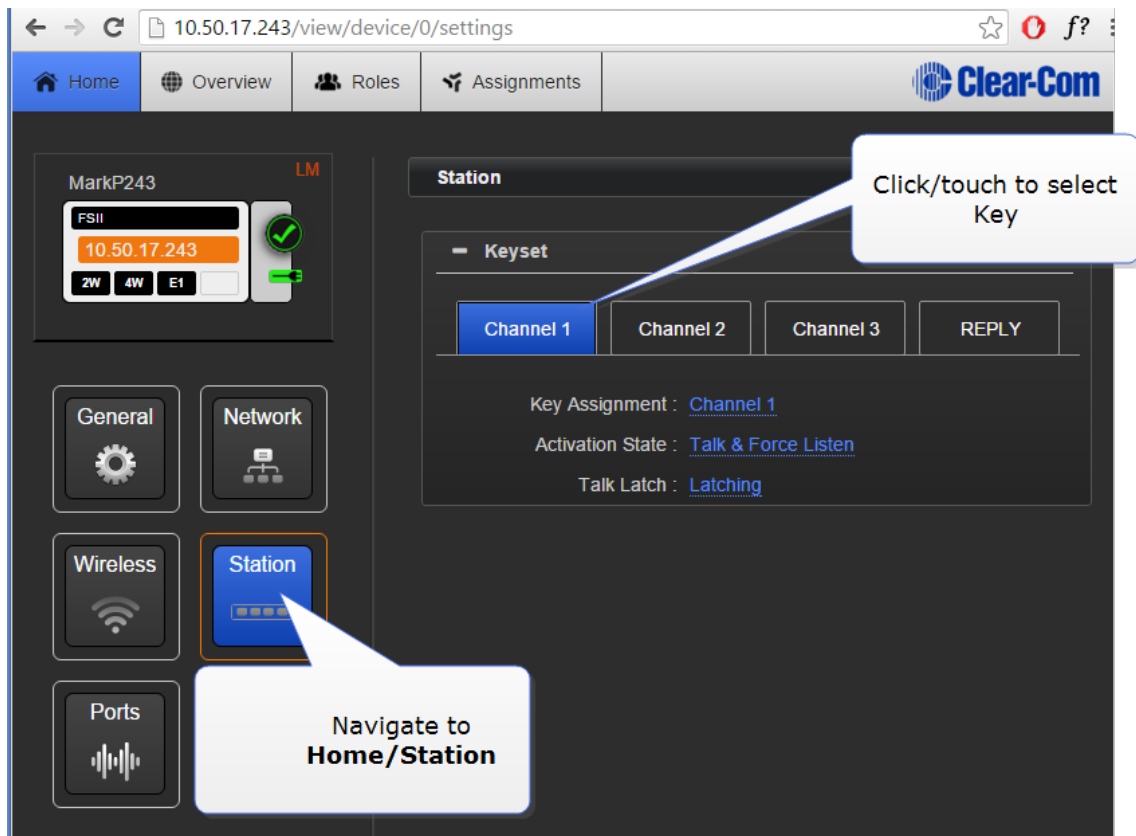

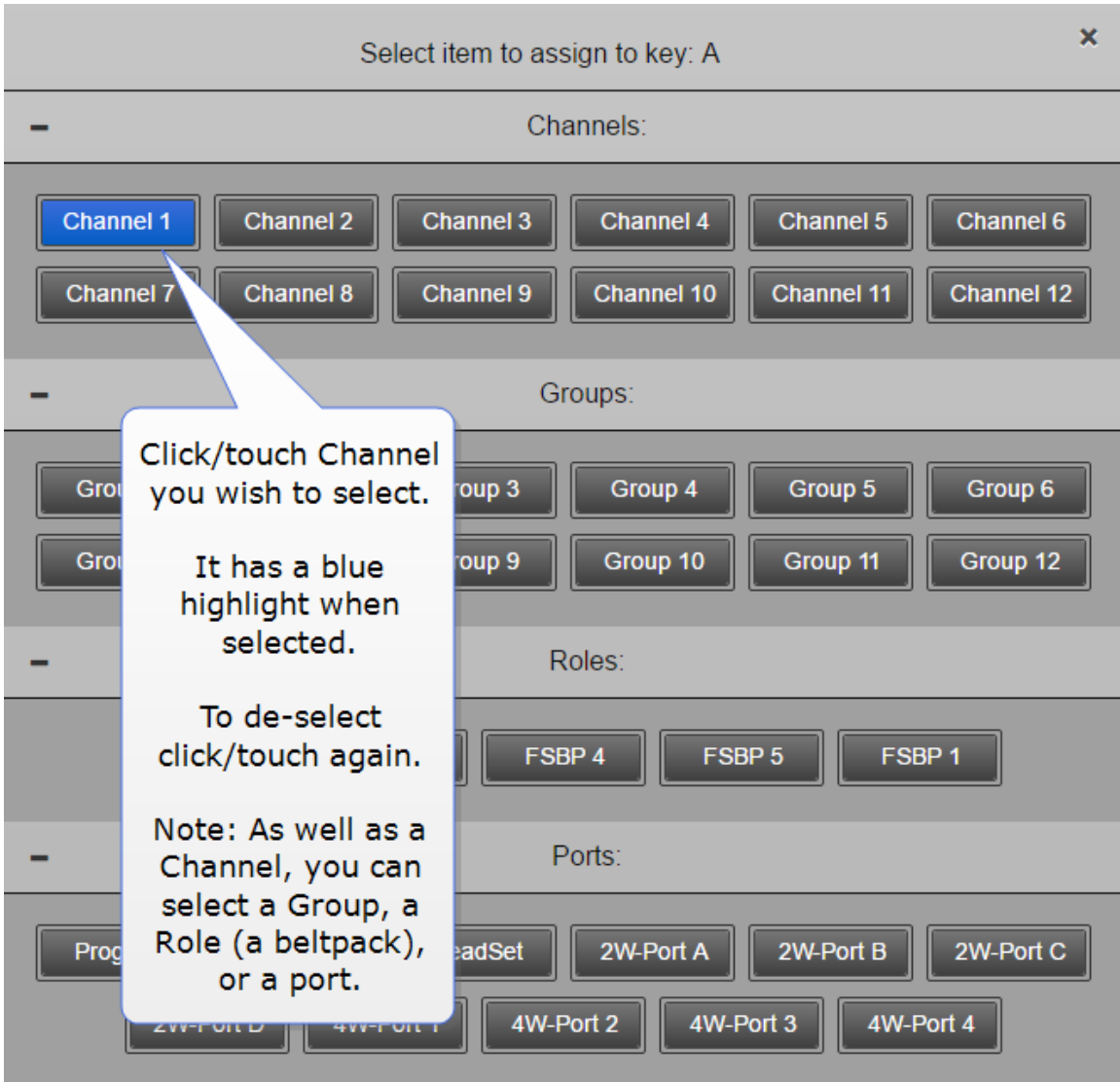

Change Base Station key assignment from the Base Station:

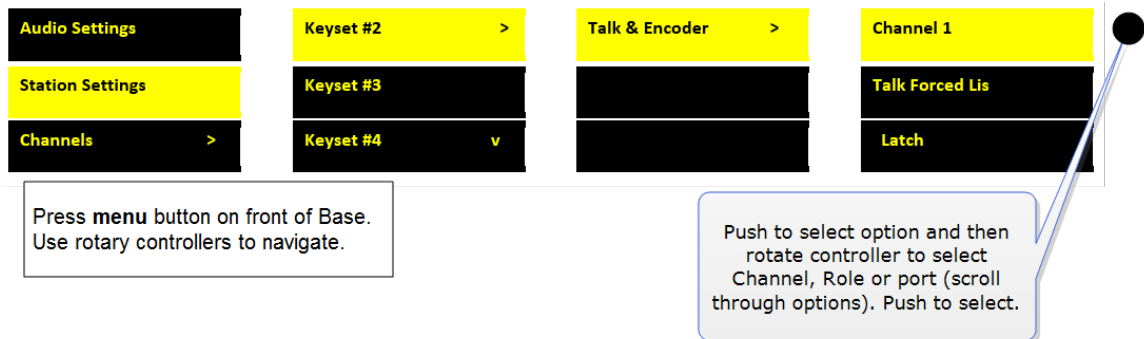

10.4 Configure a one-to-one connection

As well as into Channels, audio can be configured in a point-to-point relationship (for instance, one beltpack to another in a private communication).

10.4.1 Example point-to-point audio assignment

When selecting an audio source for any key, (in this example key C on a beltpack), instead of selecting a Channel, select a beltpack Role or port.

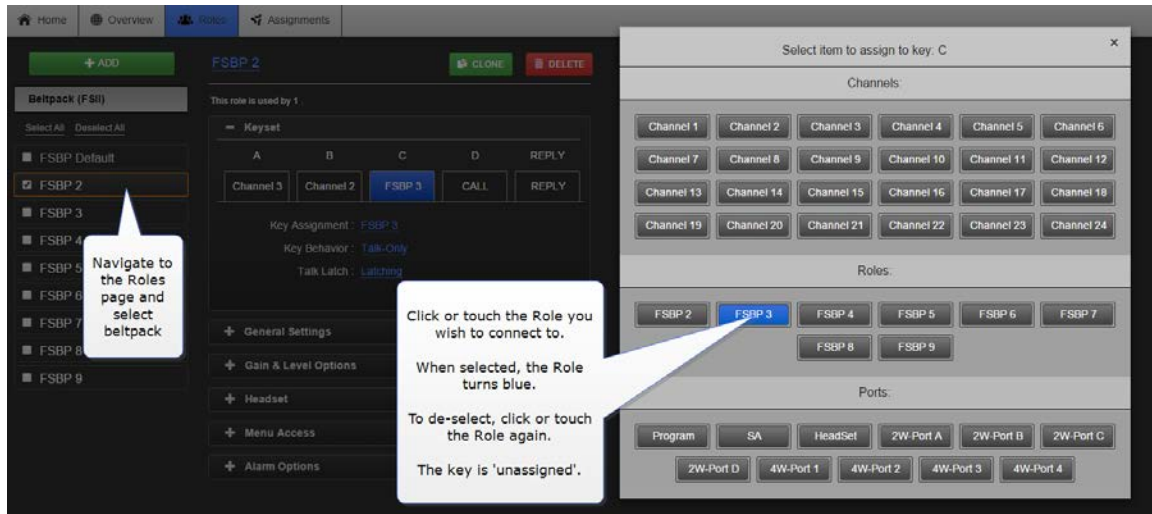

This creates a point-to-point connection. A similar effect could be achieved by putting two beltpacks into a Channel of their own.

11 *Connecting different systems*

11.1 Interconnection

FreeSpeak II Base can be connected to a range of intercom systems.

- Clear-Com Encore and RTS (2-wire cabled partyline systems)
- DX210 (2-wire/4-wire systems)
- Eclipse (digital matrix systems)
- HelixNet (digital partyline)
- Two-way radio systems
- FreeSpeak II Base can be connected to another FreeSpeak II Base station in order to share Channels between two Bases, increasing the range of your system.

11.2 Connecting FreeSpeak II Base to other intercom devices

When connecting FreeSpeak II Base to other intercom devices, the general process is the same, though there are details that change according to device type. As a general guideline you need to:

- 1) Configure the relevant interface (port) settings (see below).
- 2) Connect the device with CAT5 or microphone cable.
- 3) Adjust audio levels as required.

11.3 Connecting 2-wire equipment

When connecting 2-wire equipment the following functions should be taken into consideration:

- Auto-null. Note Every time equipment is changed on a 2-wire interface (port) you should run auto-null.
- Enable/disable the partyline power. Do this in Ports/2-Wire. Default setting: Disabled.
- Enable/disable Line termination. Note The line should only be terminated once on interconnected devices, do not terminate on more than one piece of equipment. Default setting: Disabled.

These functions can be set either in the 2-wire port settings page of the Core Configuration Manager (CCM) or from the front panel screens on the Base Station.

11.4 Connecting to 4-wire equipment

When connecting to 4-wire equipment the following need to be taken into account:

- To minimise noise, use screened (shielded) cable when connecting 4-wire ports.
- Pin-out configuration (mode) can be set on all FreeSpeak II Base 4-wire interfaces. This is a software switch that switches the configuration of the pins on the RJ45 etherCON connectors, according to the device you are connecting to. Default setting: To Matrix.

11.5 Port function (to matrix or to panel)

Check this function whenever you are connecting 4-wire devices.

11.5.1 About port function

Clear-Com products are designed so matrices can connect directly to panels/Base Station/main station using a straight-through CAT 5/6 (Ethernet) cable. The pin assignments (inputs and outputs) on these devices are complementary. Previously, a crossover cable was necessary when connecting Bases to other Bases. It is no longer necessary to use a crossover cable as there is now a Port Function toggle which changes pinouts as required. This is function is found in port options and can be set from the CCM or the Base Station front panel menus.

11.5.2 Pin assignments

Port Function pin assignments		
Pin	To Panel/Base Station	To Matrix
1	Data in +	Data out +
2	Data in -	Data out -
3	Audio in +	Audio out +
4	Audio out +	Audio in +
5	Audio out -	Audio in -
6	Audio in -	Audio out -

Port Function pin assignments		
Pin	To Panel/Base Station	To Matrix
7	Data out +	Data in +
8	Data out -	Data in -

Note: When connecting one FreeSpeak II Base to another FreeSpeak II Base, one device must be set 'To Matrix' and the other 'To Panel'.

11.5.3 Setting port function

From the CCM:

The screenshot shows the 'Local Audio ports' configuration page in the Clear-Com CCM. The 'Ports' menu item is highlighted with a callout: "Navigate to Home/Ports". Under the '4-Wire' section, '4W-Port 1' is selected with a callout: "Select 4-Wire Port". The 'Port Settings' for '4W-Port 1' are shown, with 'Port Function' set to 'to Matrix' and a callout: "Click/touch and select required option".

From the Base Station:

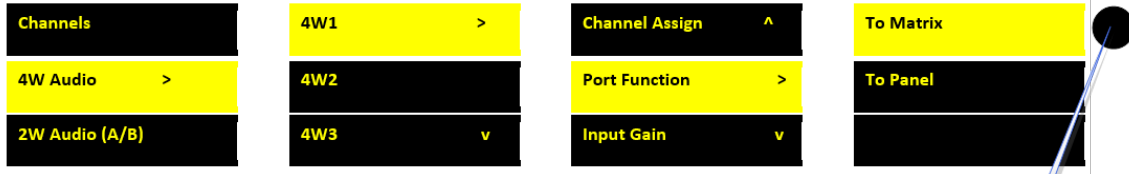

Press **Menu** key. Scroll to required option using rotary controllers

Use rotary controller to scroll to required setting. Push to select/commit.

12 Upgrading devices

12.1 About upgrading devices

To upgrade your devices, you will need to import the upgrade file provided by Clear-Com into the unit. This can be done either from the browser-based configuration tool (the CCM) or from the Base Station front menu screens. The process is the same for each device type.

Device type	File type (where xxxx = revision no.)
Base Station	FSII_XXXXX.gz
Beltpack	PP_XXXXX.FFW
Antenna	RFP_XXXX.FFW

12.2 How to upgrade your devices

Upgrade from the CCM:

The screenshot shows the Clear-Com CCM interface. The navigation bar at the top includes Home, Overview, Roles, and Assignments. The main content area displays the 'General' settings for a device (FSII#1). The 'General' tab is selected, and the 'Upgrade' section is expanded. The 'Upgrade' section contains a 'Select File' button (labeled 1) and an 'Upgrade' button (labeled 2). Callout boxes provide instructions: 'Navigate to Home/General', 'Click/touch \"+', '1. Click/touch **Select File** then navigate to where you have stored upgrade file and click on it to load the file.', and '2. When file is loaded, **Upgrade** will light up. When this happens, click on it to upgrade. Wait while devices upgrade and reboot.'

Upgrade from the Base Station:



Insert USB stick here

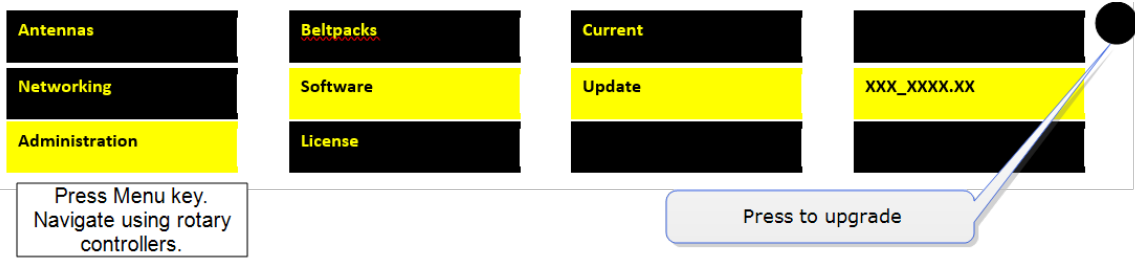

Note: The FSII splitter is not user upgradable. Contact Clear-Com, LLC if you need more information.

13 Powering your system

13.1 Powering the FreeSpeak II™ Base

Use two power supplies according to preference:

- Mains power lead (internal power converter)
- DC connector. External wallwart power lead.

Use one power connector or both to guard against one failing.

13.2 Powering wireless beltacks

Beltacks are powered by Li-ion battery. Drop-in battery charger supplied.

Battery power status is viewed from:

- Base Station menu screens
- Beltack menu screens
- Core Configuration Manager (CCM).

For more information, see: **Battery Charger Quick Start Guide** (PDF available from Clear-Com, LLC website).

Note: You can also power beltacks using standard AA batteries for convenience. In situations where Li-ion batteries are prohibited, you can also use nickel metal hydride batteries (NiMH) but will need to set battery type so battery life diagnostics are accurate.

13.3 Power 2-wire beltacks from the Partyline

2-wire Partyline beltacks can take power from the Partyline:

- FreeSpeak base power: 60 watts supply = 250 mA to Partyline
- ~10 beltacks per pair of ports, max 20 beltacks per base.

Note: The Partyline power operates over a pair of ports

To enable power to the Partyline go to Ports, 2-wire in the CCM or in Base front menu screens.

13.4 Powering the transceiver antennas

- Directly (DC in power connector) or
- From the FreeSpeak II™ Base

Direct power to antenna is recommended. Local (direct) power will increase how far antenna can be positioned from the Base

Antenna powered locally:

- Shielded Ethernet cable up to 800 m (2,625 feet) from base or splitter.

Antenna powered from Base Station (1 antenna only):

- Shielded Ethernet cable, up to 300 m (984 feet) from base.

Note: Using heavier gauge cable will increase available distance.

For more information, see:

- Using the Antenna
- Site survey and RF issues

13.5 Powering the Antenna Splitter

The splitter **MUST** be powered locally. Power the splitter before you connect it to the base, or it will take power from the base and this may be insufficient.

Use the supplied power connector.

13.6 Recommended powering and cable lengths for a FreeSpeak II Base System

Possible distance from Base Station to antenna

The Base Station can power 1 antenna to a distance of 300 meters (984 feet). More than one antenna and/or greater distances will need direct power supplied to the antenna.

The figures in this table are based on the use of 24AWG Cat5/6 cable	Capacity (distance and no. of devices)
Base to antenna. No PSU at antenna.	1 antenna only. 300 meters (984 feet).
Base to antenna. PSU at antennas.	2 antennas. 800 meters (2625 feet).

Base to splitter. Splitter must have PSU.	800 meters (2625 feet).
Splitter to antenna. Antennas powered by splitter, no PSU at antenna.	5 antennas per splitter. 300 meters (984 feet).
Splitter to antenna. PSU supplied to antennas.	5 antennas per splitter. 800 meters (2625 feet).

Note: Distance between Base and antennas can be increased by connecting via Fiber.

14 **Federal Communications Commission (FCC) compliance**

FCC Notice

This device complies with Part 15 of the FCC rules. Operation is subject to the following two conditions: (1) This device may not cause harmful interference, and (2) This device must accept any interference received, including interference that may cause undesired operation.

NOTE: This equipment has been tested and found to comply with the limits for a Class A digital device, pursuant to Part 15 of the FCC rules. These limits are designed to provide reasonable protection against harmful interference when the equipment is operated in a commercial environment. This equipment generates, uses and can radiate radio frequency energy and, if not installed and used in accordance with the instruction manual, may cause harmful interference to radio communication. Operation of this equipment in a residential area is likely to cause harmful interference, in which case the user will be required to correct the interference at his own expense.

Changes or modifications not expressly approved by Clear-Com, LLC, an HM Electronics, Inc. company could void the user's authority to operate this equipment.

Industry Canada Compliance Statement

This Class[A] digital device complies with Canadian ICES-003.

Avis de conformité à la réglementation d'Industrie Canada

Cet appareil numérique de la class[*] est conforme à la norme NMB-003 du Canada.

Korean Notice

A급 기기 (업무용 방송통신기자재)

이 기기는 업무용(A급)으로 전자파적합기기로서

판매자 또는 사용자는 이 점을 주의하시기

바라며, 가정외의 지역에서 사용하는 것을

목적으로 합니다.

FreeSpeak II Base products comply with the following specifications:

EN55022 Emissions

EN55024 Immunity

Electromagnetic Compatibility Directive 2004/108/EC

Low Voltage Directive 2006/95/EC

IEC60950-1

Warning:

This is a Class A product. In a domestic environment this product may cause radio interference in which case the user may be required to take adequate measures.

Waste Electrical and Electronic Equipment (WEEE)

The European Union (EU) WEEE Directive (2002/96/EC) places an obligation on producers (manufacturers, distributors and/or retailers) to take-back electronic products at the end of their useful life. The WEEE Directive covers most Clear-Com products being sold into the EU as of August 13, 2005. Manufacturers, distributors and retailers are obliged to finance the costs of recovery from municipal collection points, reuse, and recycling of specified percentages per the WEEE requirements.

Instructions for Disposal of WEEE by Users in the European Union

The symbol shown below is on the product or on its packaging which indicates that this product was put on the market after August 13, 2005 and must not be disposed of with other waste. Instead, it is the user's responsibility to dispose of the user's waste equipment by handing it over to a designated collection point for the recycling of WEEE. The separate collection and recycling of waste equipment at the time of disposal will help to conserve natural resources and ensure that it is recycled in a manner that protects human health and the environment. For more information about where you can drop off your waste equipment for recycling, please contact your local authority, your household waste disposal service or the seller from whom you purchased the product.



15 Specifications

Specification	Value
Base Station to beltpack frequency response	100 - 7.1 Hz
Number of FS II beltpacks per Base Station	5 (FS-BASE-II-5) or 25 (FS-BASE-II), depending on model
Number of antennas (FS-TA) supported by Base Station	2 direct or 10 via antenna splitters
Number of antenna ports	2 x RJ45, 2 x Fiber (2 active at any time)
Programming port	2 x LAN
GPIO port	DB15; <ul style="list-style-type: none"> • 4 x relay outputs, normally open and normally closed wiring • 2 x GPI
Partyline: A,B,C,D	XLR-3F, ON/OFF termination control. Power ON/OFF (A/B, C/D paired)
4 -wire	4 X RJ45 for 4-wire
Program input	XLR-3F, transformer isolated, line-level input, independent Program Input level control via rotary encoder
Stage Announce output	XLR-3M, transformer isolated, line-level output with dedicated front panel Talk key
Front panel headset	4-pin (or 5-pin male connector depending on model. Automatic mic detect

Specification	Value
4 x programmable front panel keysets	<ul style="list-style-type: none"> • 128 x 64 OLED • Talk and Call keys with LEDs • Listen key on rotary encoder for level control (with LED)
Front panel buttons	<ul style="list-style-type: none"> • Headset mic ON/OFF • Monitor display (Mode) • Configuration Menu • Stage announce Talk (SA) • All Talk • Remote mic kill (RMK)
Front panel indicators	<ul style="list-style-type: none"> • Antenna status • Beltpack status
Front panel encoders	Program input level control with cut and LED indication
Radio frequency (RF) synch	Rear RF input and output sync connectors
Power input	<ul style="list-style-type: none"> • Internal power supply with IEC C14 connector (male) • DC input connection for 12V DC
Dimensions	1 RU 44 x 442 x 250 mm (1.75 x 17.4 x 9.8 inches)
Weight	Approx. 2.3 kg (5 lb)